

PRODUCT CATALOG

2023



FIRETECH®

BY HIVIZ LED LIGHTING

TABLE OF CONTENTS



4

INTRODUCTION TO FIRETECH®



12

NEW WARNING LIGHTS

HiViz Connect™ (HVC) Intro.
HVC Omen™ Warning Lightbar
HVC Guardian® Warning Lights

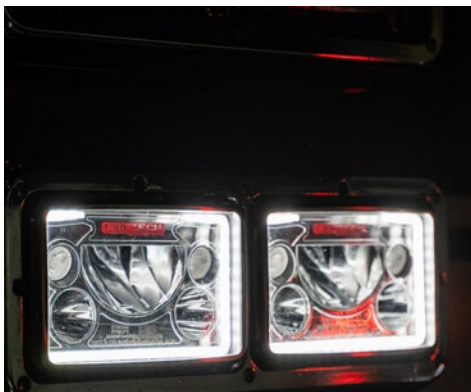

26

DOT LIGHTS

4x6 Headlights
5.75" Round Headlights
7" Round Headlights
NEW Guardian® Jr Tail Lights



34

BAR-STYLE FIXTURES

BG2 Smart Lights
BG2S User Interface Panel
Brow Lights
MiniBrow® Lights



46

SURFACE & RECESSED SCENE LIGHTS

Guardian Series Scene Lights
Recessed / Semi-Recessed Lights
Under-Aerial Lights



52

COMPARTMENT & UNDERCARRIAGE LIGHTS

HD Strip Lights
Undercarriage Lights
NEW Dome Lights



56

LIGHT TOWERS

Command Light Tower Lighting
Will-Burt Tower Lighting



60

POLE LIGHTS

Guardian Pole Mounted Lights
Patriot Pole Mounted Lights
20,000 Raw Lumen LED Scene Light
30,000 Raw Lumen LED Scene Light



64

WORK LIGHTS

WL-X Xtreme Series Lights
Work & Area Lights



70

SPECIALTY LIGHTS

Pixel Ladder Lights
Laser Cannon Lights
Retrofit Lights
FireTech Grilles
Camera Integrated Lights



80

SOFTWARE & LIGHTING ACCESSORIES

Field Support Tool
Omen™ Lightbar Accessories



ABOUT THE FIRETECH® BRAND

BY HIVIZ LED LIGHTING®

WE HELP FIRST RESPONDERS WORK MORE SAFELY AND EFFECTIVELY AFTER DARK, **SO THEY CAN SAVE LIVES.**

We do this by providing reliable lighting technologies for emergency vehicles. Our team is dedicated to developing the most innovative, durable, and high performance lighting products on the market.



MORE LIGHT

With the highest luminous efficacy on the market, our fixtures produce more lumens per watt than others on the market. That means more light, where you need it, every single time.



BETTER LIFETIME WARRANTY

Our fixtures are built to last. Therefore, HiViz is proud to offer a Lifetime Warranty WITH advance exchange on all FireTech products. Advance exchange means that we ship you a new fixture first and then you send us the old one back after the swap. We can't promise that you'll never have a problem, but we can promise that we'll take care of it if you do.



SAME COST

Lumen for lumen, HiViz fixtures beat the competition in both performance and price. What does this mean? You get the light output you deserve at a price point you can afford.



DEVELOPED BY FIRST RESPONDERS

We've responded to roadside emergencies in the middle of the night, so we know the challenges that you face. Our team is comprised of first responders and we take our real world knowledge into account when designing and engineering our products.





LIGHTING QUALITY AS A PRIORITY



INGRESS PROTECTION

Products are sprayed from close distances with 80~100 bar water pressure to verify the ingress protection rating, ensuring they are sealed properly.



SUBMERSION & AGING

Every product is run through a submersion (water dunk) test, then placed onto an aging rack and powered up for 30 minutes.



THERMAL IMPACT

Products are placed in a -40°C chamber for 30 minutes and then placed in an 80°C chamber for an additional 30 minutes. Products are then powered up for 72 hours.



LONG TERM DURABILITY

Products are switched on and off 150,000 times repeatedly to ensure that they remain functional after all testing.



CONSUMPTION & INPUT RANGE

All products are tested with a digital power meter to ensure that they are consuming the correct amount of power and have no electrical faults.

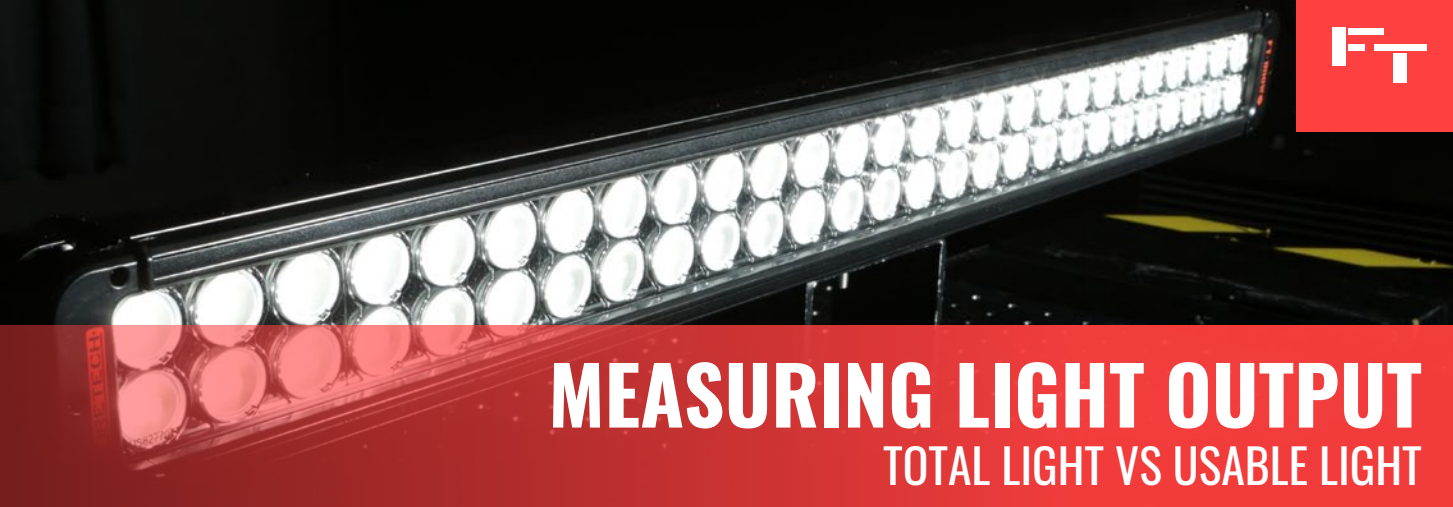

MEASURING LIGHT OUTPUT

TOTAL LIGHT VS USABLE LIGHT

LUMENS VS. LUX

Lumens is the measurement of light at the source. Lux (or Foot Candles) is the measurement of light on a specific target. Analogous to fire fighting, lumens is GPM/Flow, lux is where the water droplets land. Changing from fog to straight stream does not affect the flow rate, it just affects where the water lands. Similarly, lumens at the source does not tell you how much light is where you're working, just how much light is produced. Temperature of circuit is analogous to friction loss.

In general, adequate work lighting levels in the Fire/Rescue/EMS industry are defined as somewhere between three and 10 lux on target. At one lux, you generally have enough light to read a newspaper.

USABLE LIGHT = **LUX / F.C.**
TOTAL LIGHT OUTPUT = **LUMENS**

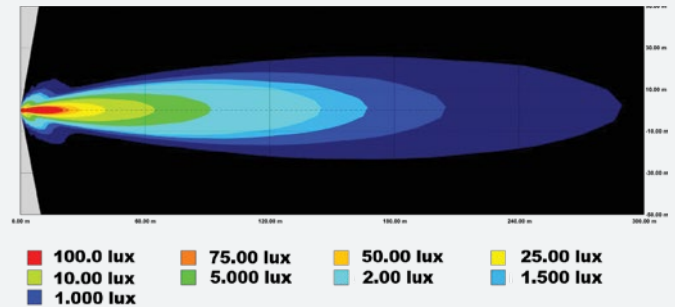

RAW LUMENS VS. EFFECTIVE LUMENS

Lumens are a common standard for measuring light output at the source. It is important to know that the LED chip manufacturer rating is only for the light source in a perfect world, at a perfect temperature and does not account for losses due to optical inefficiencies, electrical inefficiencies, or heat.

The sum of the rated output of the LED chips (Raw Lumens) is not enough to capture the whole story. When measuring effective output, the amount of light lost as heat, optical scattering, or electrical inefficiency must also be considered. Effective lumens are measured in a machine called a goniophotometer and the measurement allows comparisons between fixtures using reproducible scientific "IES" data. This is the ONLY fair way to compare lights made by different manufacturers. HiViz LED Lighting® is happy to provide photometric isolux reports on any product, upon request.

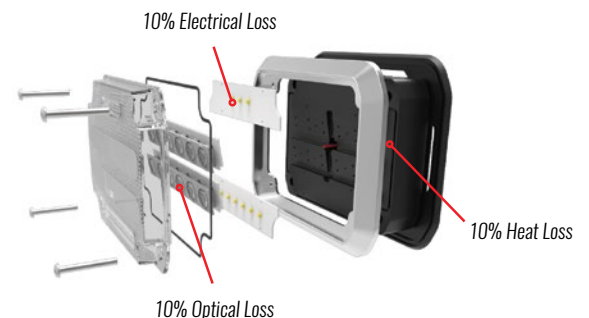



CUSTOM LIGHTING SPEC

WE'LL CREATE PERSONALIZED RECOMMENDATIONS SPECIFIC TO YOUR APPARATUS

WHAT TO EXPECT WHEN YOU WORK WITH US

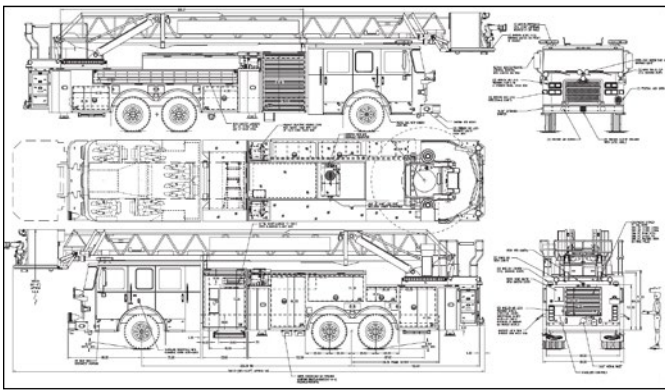

2D BLUE PRINT

We begin each project with a customer/dealer provided drawing of the rig to be outfitted, as well as a quick conversation with the customer on the duties of the particular rig and the response district.

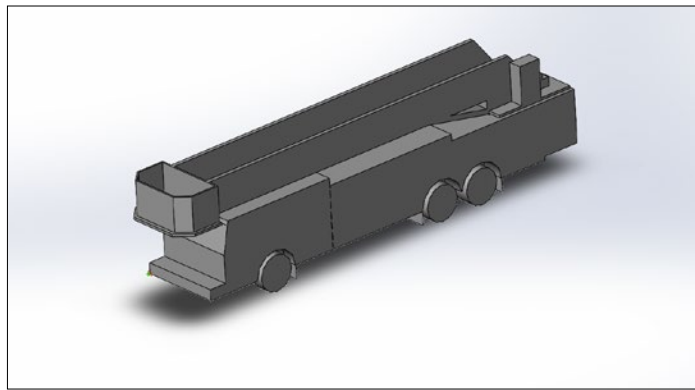

3D MODEL

A 3D model is built using the customer's specifications then carried over into the rendering engine.

Rear Scene Lighting

The grid points in the heat-map rendering are set at 10-foot increments. The fixture provides above 1 lux on the ground around 80' to the rear of the apparatus.

Recommendation: The FT-65MR, also known as the Guardian Junior, is a surface-mounted light with the same design characteristics as the Guardian Elites on the side of the cab. Included the photo above to show two of these placed in the same location as we are recommending on the rear of your truck. By using these fixtures, the department is avoiding the light being placed right in the line of sight when pulling ladders.

- FTWL-15-FT***
FinTech 30 LED extreme durability scene light, 28,000 lumens, FT combination spot/flood optics that doubles well as a draw light, for mounting on the front of the bucket. Lifetime Warranty.
- FTLR-401T**
FinTech LED Headlights. Lifetime Warranty.
- FE55MR**
Guardian Elite surface mounted light. Asymmetric beam pattern. 20,500 lumens. Lifetime Warranty.
- FTMR-2-27-F***
FinTech Mini Draw light with two rows of LEDs, 54 LEDs in total, 28,512 lumens, 30-Inches. Recommended all-flood optics for the side of the body for lighting a broad area around the rig. Lifetime Warranty.
- FE55MR**
FinTech Guardian Jr. surface-mounted scene light, 5,000 lumens each. Lifetime Warranty.
- FTWL-8-B-F* CPRE-FIX**
FinTech 9 LED extreme work light, 12V, 7,200 lumens, Symmetrical flood beam pattern recommended. Recommended mounting on the bottom of the platform. Lifetime Warranty.
- FTWL-8-S***
9 LED extreme work light, 7,200 lumens, Symmetrical beam pattern. Spot optics for aerial spotting lights. Lifetime Warranty.
- FECL-40-40T**
Sub-Aqua Undercarriage Light, Wide Flood Optics, 17W & 40. Lifetime Warranty. **Mid/White fixtures also available.
- FECL-40***
** Heavy Duty Compartment Light (Sho as needed based on Pierce) Lengths include 7.5', 12', 24', 36', 48' and the number is in place of the Lifetime Warranty.

SIMULATION RENDER

A simulation rendering ensures the final product will meet the customer's lighting requirements, as well as any applicable agency standards.

CUSTOM SOLUTION

We create a complete breakdown of the customer's specific needs to meet their safety requirements.

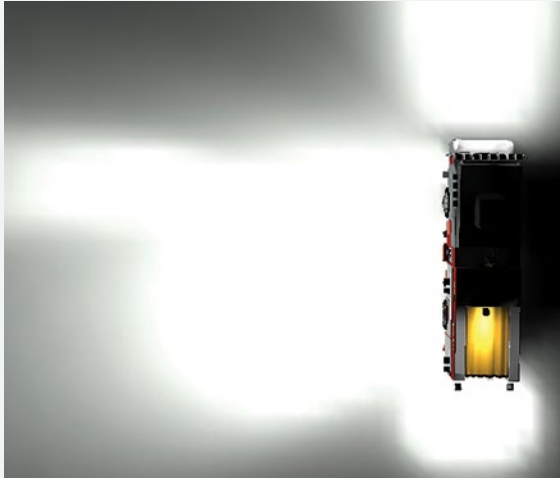

REALISTIC AND ACCURATE LIGHTING SPEC

Spec'ing a new rig and don't know where to begin? Send your drawing to have our team recommend a layout! This service doesn't cost anything and it's a great way for you to ensure efficient and thoughtful placement of scene lights around your rig!

Our team can typically produce a detailed rendering within five to ten business days, if provided proper vehicle specifications.

GET YOUR CUSTOM LIGHTING SPEC

Fill out this worksheet and text a picture of it to **(703) 662-3458** or email it to **firetech@hivizleds.com** and we'll send you your custom fit out guide.

NAME OF FIRE DEPARTMENT: _____

TYPE OF FIRE DEPARTMENT (CAREER OR VOLUNTEER): _____

BUDGET: WE'RE ON A TIGHT BUDGET BALANCE PERFORMANCE AND COST WE NEED INSANE AMOUNTS OF LIGHT

DESIGN GOALS/NOTES: _____

TYPE OF TRUCK (RESCUE, PUMPER, ETC): _____

BRAND OF TRUCK: _____

RURAL OR CITY: _____

LONG SET BACKS: YES NO

LIGHT TOWER IN FLEET: YES NO

EMAIL: _____

PHONE: _____





VISIT OUR WEBSITE OR SCAN TO REQUEST
A **CUSTOM LIGHTING SPEC**

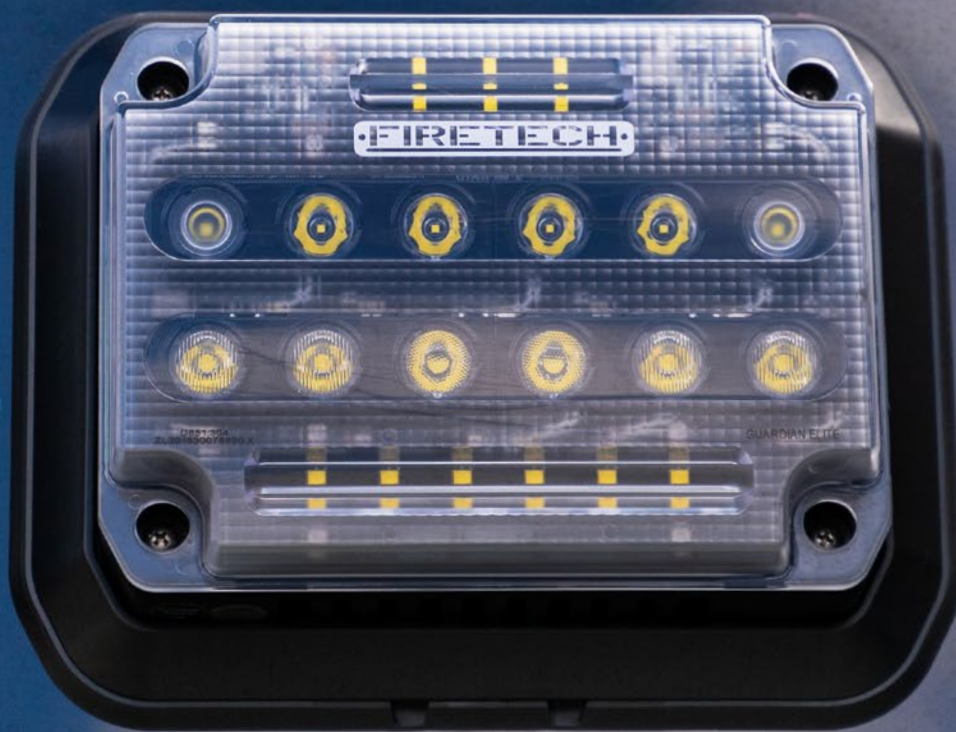

BLACKOUT LED LIGHTS

We've all seen the trend...murdered out fire apparatus are here to stay! The FireTech® brand has a large selection of blackout fixtures specifically designed for these applications!



 FIRETECH 4X6 HEADLIGHTS | PG. 28  FIRETECH BROW LIGHTS | PG. 40

 GUARDIAN® SCENE LIGHT | PG. 48  GUARDIAN JR SCENE LIGHT | PG. 48

HOW TO CONFIGURE YOUR PART NUMBER



PART NUMBER BREAKDOWN†

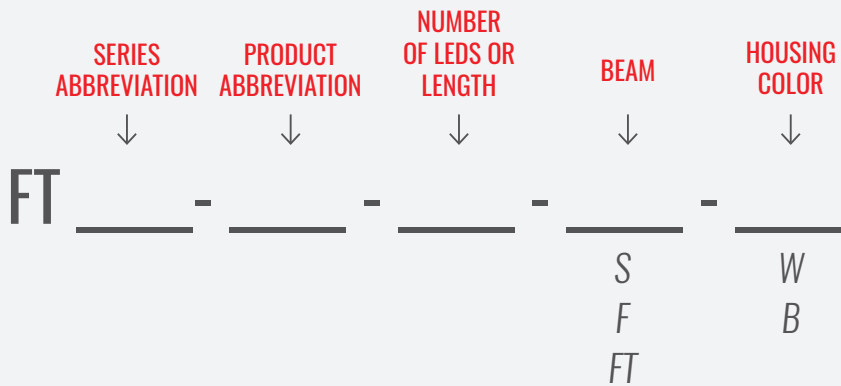

SERIES ABBREVIATIONS

- HVC** HIZVIZ CONNECT™ SMART SERIES
- IDL** INTERIOR DOME LIGHTS
- WL** WORK & AREA LIGHTS
- CU** COMPARTMENT & UNDERCARRIAGE SERIES

PRODUCT ABBREVIATIONS

- OMEN** OMEN™ WARNING LIGHTBAR
- GESM** GUARDIAN™ ELITE
- GSM** GUARDIAN
- GSMJR** GUARDIAN JR.
- BG2** BG2
- B** BROW LIGHT
- MB** MINIBROW®
- SL** POLE MOUNTED
- PSL** PATRIOT POLE MOUNTED
- X** WORK LIGHT XTREME
- HD** COMPARTMENT LIGHT
- AQX** UNDERCARRIAGE LIGHT
- 8RD** 8" ROUND DOME LIGHT
- 719RCT** 7X19" DOME LIGHT
- PXL** PIXEL LIGHT
- P48** PAR 46

NUMBER OF LEDS OR LENGTH

Number will vary depending on product; please see individual product page or visit our website to select which size or LED amount is right for you.

HOUSING COLOR OPTIONS *

W=WHITE



B=BLACK



AVAILABLE BEAM PATTERNS *

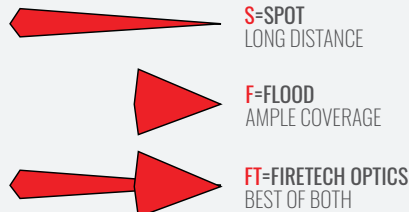

EXAMPLE OF CONFIGURED PART NUMBER

FT-HVC-B-72-ML-B

(HIZVIZ CONNECT - BROW LIGHT - 72" - MARKER LIGHTS - BLACK)

† Not all products have each of these options available. For more details please refer to the individual product page or our website to configure your exact part number.

WARNING LIGHTS





WARNING LIGHTS



HARDWARE NOW. **SOFTWARE OVER AND OVER.**

In a manufacturing environment where long backlogs and lengthy production lead times are the new norm, choosing a lighting system that can be updated over time helps to ensure you don't miss out.

HiViz Connect™ is the communication protocol that enables smart features in our new HVC Warning Lights. With HiViz Connect, our hardware products become virtually future-proof: feature enhancements and updates can be downloaded and sent to your warning lights without ever having to take them off the truck. We took our inspiration from some of the most forward-thinking car manufacturers in the tech space, and have designed a feature set that become exponentially advanced with time. The best part? There's no expensive central brain box. It's all built into the fixtures and does not require a secondary electrical system to be installed on your apparatus.

The ability to update the software wirelessly will allow us to roll out updates keeping your truck up-to-date. With HiViz Connect, you can spec FireTech® today and receive the latest features the day your truck is ready to ship.

HiViz
CONNECT™



ADVANCED FLASH PATTERN PROGRAMMING

HiViz Connect™ enables features like dimming, ramping, and virtually unlimited flexibility in flash pattern selection.

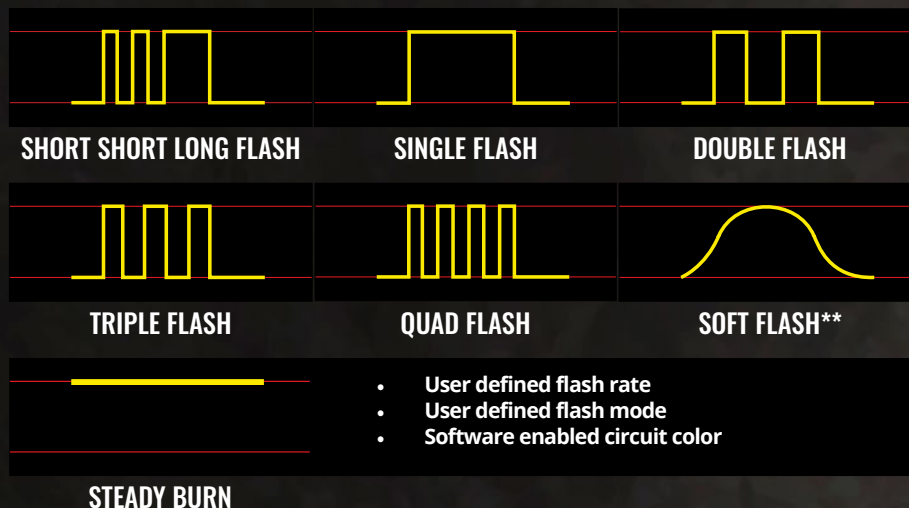

MULTI-VEHICLE SYNCHRONIZATION*

Quickly becoming a requirement in many regions, stay on top of new safety regulations with synchronizing flash patterns and rates across vehicles.



ACTIVE LOAD MANAGEMENT

Firefighters should never have to work in the dark. Active load management ensures the scene and warning light fixtures never consume more power than the alternator has capability to produce. This allows for the lights to be dimmed rather than just switched off if electrical system capacity is exceeded.



AUTOMATIC SYSTEM-WIDE NIGHT MODE

Night modes have been recognized in NFPA 1900 as a possible way to reduce chaos and calm the emergency scene. HiViz Connect-enabled products automatically enter night mode, slowing the flash rate and reducing intensity for the entire system with no user input required.



INTEGRATED DIGITAL ALERTING*+

By transmitting data in to the HAAS Alert Safety Cloud®, millions of motorists have the ability to receive a digital notification when you are responding on scene to make the roads safer for all.

* Feature to be released in future software updates

**All Soft Flash patterns include an interval where the light emission turns completely off

+Requires active HAAS Alert subscription and optional hardware package (included with most new apparatus at no cost)

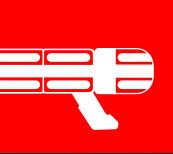

CONNECT TO THE WORLD AROUND YOU*

Lights and sirens alone will never totally solve the problem of motorists and autonomous vehicles crashing in to parked emergency vehicles.

FireTech® Omen™ Warning Lightbar is designed to connect seamlessly with HAAS Alert's Safety Cloud®. In retrofit applications, install a HA5 or HA7 directly on the warning lightbar's exoskeleton, connect the interface cable, and immediately connect with the world around you. On new apparatus, simply connect the HiViz Connect™ network to the HAAS Alert supplied on your apparatus and enable an advanced set of features through a software update.

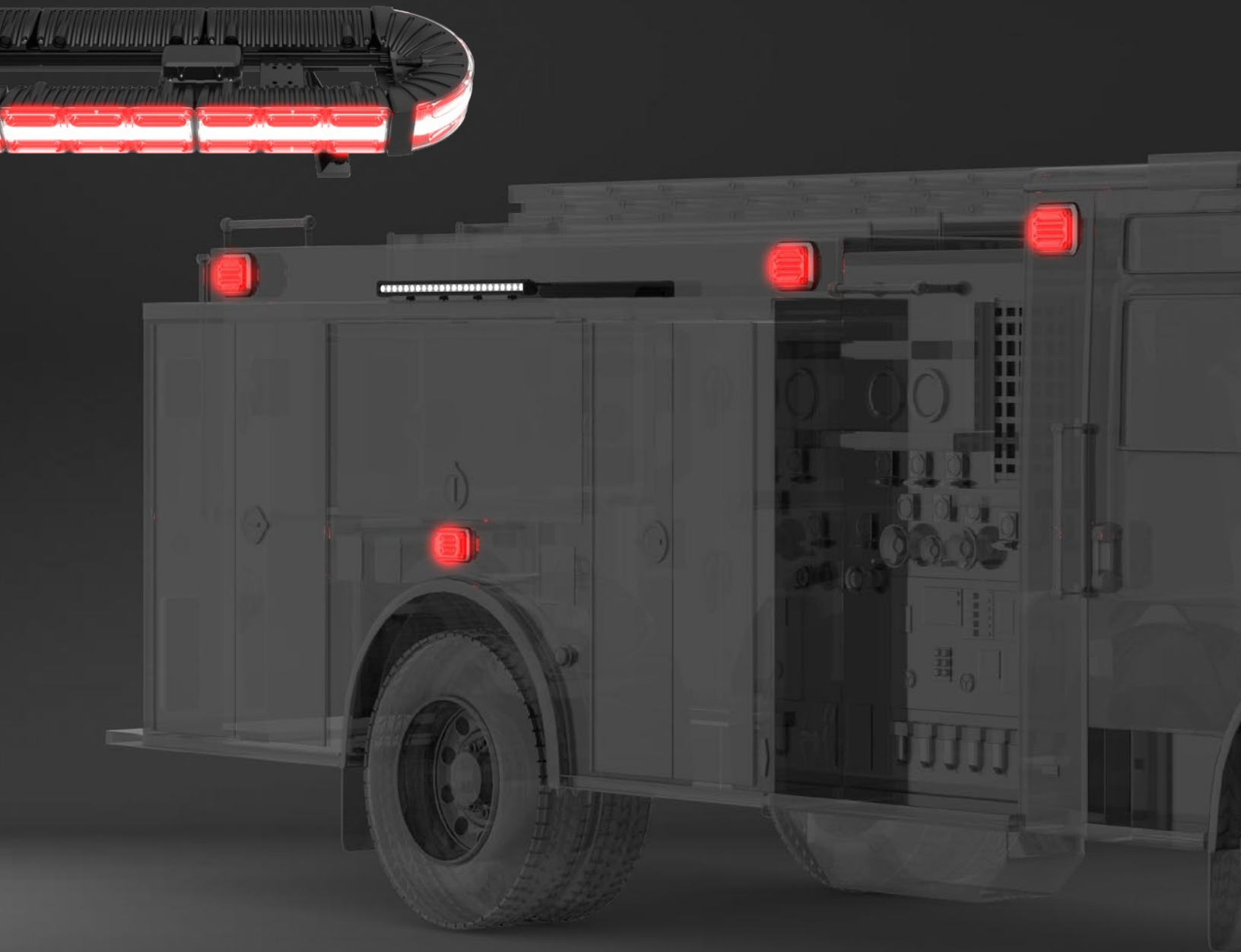

* Feature availability announcements coming soon. All hardware complete as of date of this publication, compatibility and integration to be enabled in software after purchase.



When a HAAS Alert device is connected, the lightbar becomes a smart internet-connected beacon which alerts motorists and other first responders of your presence while responding and on scene- regardless of the brand of lights they choose! In addition, adding a HA5 or HA7 device to your system can enable over-the-air software updates for your fixtures, feature expansions, simple access to setting configurations, and intelligent multi-vehicle lighting controls.

Expanding your emergency vehicle's warning system to include technology like Digital Alerting is the natural 21st century solution to safer roads. Contact HiViz for more info.



**SAFETY
CLOUD[®]**
POWERED BY HAAS ALERT

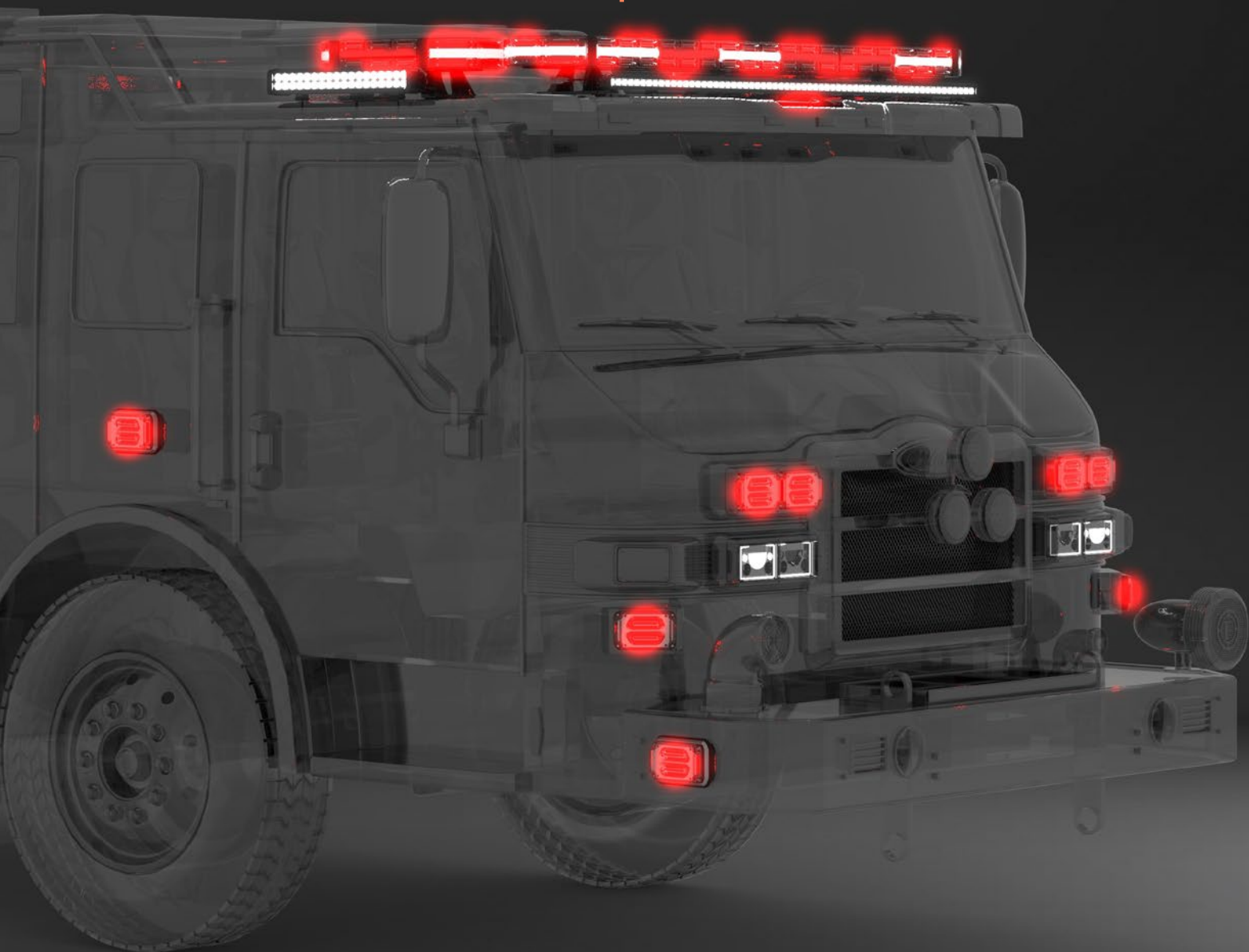





NEW OMEN™ WARNING LIGHTBARS

24"-84" HIZVIZ CONNECT™ CONFIGURED WARNING LIGHT FIXTURES

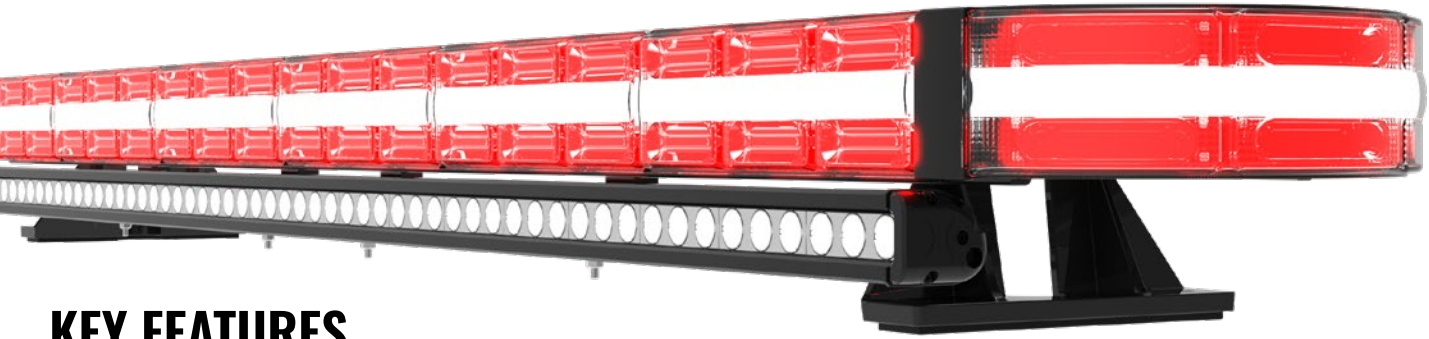
OMEN™



KEY FEATURES

- Optional mounting for FireTech® brow light underneath with the J-Foot mounting bracket. See page 45 for ordering information
- Eight user selectable system-wide standard inputs (controls all fixtures on apparatus). Add 14 additional inputs using expansion module (see page 83 for more information)
- Virtually unlimited flash patterns and user programmable traffic director functions
- Automatic night mode
- Two HiViz Connect™ outputs provide full warning/scene light system control via single-wire interfaces
-  **Bluetooth**™ enabled functionality coming soon! Hardware installed now, wireless functionality enabled in future software updates

THE OMEN WARNING LIGHTBAR

Every FireTech® Omen lightbar comes fully populated with every color in the middle row. This reduces complexity and eliminates the need for you to spend time in a configurator prior to spec'ing your apparatus. Choose your length, mounting location, and whether or not you want to add a smart FireTech brow light and let the truck manufacturer do their thing. Gone are the days of needing spare modules and internal parts of warning lightbars. With the Omen, you can focus on the job at hand.





OMEN™ WARNING LIGHTBAR MODELS

HiViz
CONNECT™

FT-HVC-OMEN-24 | 1 MODULES | 3 ILLUMINATED SIDES*



FT-HVC-OMEN-36 | 2 MODULES | 3 ILLUMINATED SIDES*



FT-HVC-OMEN-48 | 3 MODULES | 3 ILLUMINATED SIDES*



FT-HVC-OMEN-60 | 4 MODULES | 3 ILLUMINATED SIDES*



FT-HVC-OMEN-72 | 5 MODULES | 3 ILLUMINATED SIDES*



FT-HVC-OMEN-84 | 6 MODULES | 3 ILLUMINATED SIDES*



* These standard options come with lights on three sides of the fixture, lights on all four sides of the fixture are available via special request.

BEACON/HALF BEACON LIGHT MODELS

FT-HVC-OMEN-12 | MICRO-SIZED BAR / BEACON | 360 DEGREE ILLUMINATION



FT-HVC-OMEN-6 | HALF BEACON | 180 DEGREE ILLUMINATION



ITEM #	DESCRIPTION
FT-HVC-OMEN-24	24" Omen Minibar, Red LEDs, RGBAW Center Row, HiViz Connect Enabled. 3 Illuminated Sides.
FT-HVC-OMEN-36	36" Omen Lightbar, Red LEDs, RGBAW Center Row, HiViz Connect Enabled. 3 Illuminated Sides.
FT-HVC-OMEN-48	48" Omen Lightbar, Red LEDs, RGBAW Center Row, HiViz Connect Enabled. 3 Illuminated Sides.
FT-HVC-OMEN-60	60" Omen Lightbar, Red LEDs, RGBAW Center Row, HiViz Connect Enabled. 3 Illuminated Sides.
FT-HVC-OMEN-72	72" Omen Lightbar, Red LEDs, RGBAW Center Row, HiViz Connect Enabled. 3 Illuminated Sides.
FT-HVC-OMEN-84	84" Omen Lightbar, Red LEDs, RGBAW Center Row, HiViz Connect Enabled. 3 Illuminated Sides.
FT-HVC-OMEN-12	12" Omen Beacon, Red LEDs, RGBAW Center Row, HiViz Connect Enabled. 360 Degree Illumination.
FT-HVC-OMEN-6	6" Omen Half Beacon, Red LEDs, RGBAW Center Row, HiViz Connect Enabled. 180 Degree Illumination.

DIMENSIONS

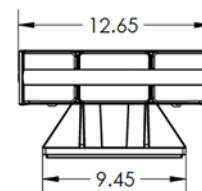
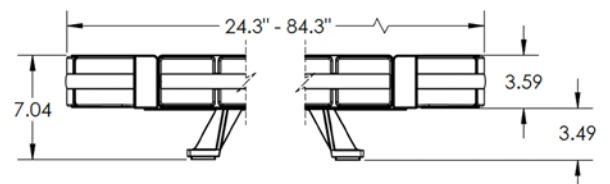

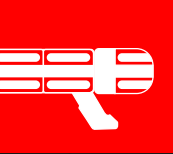

OMEN

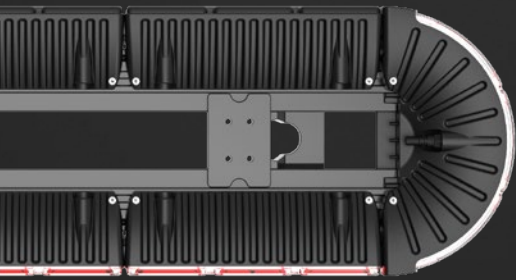

ALL NEW DESIGN & NEW FEATURES

In 2023, there's no need to have access to the internal central brain of a lightbar. In fact, with the Omen, there is no center at all. Rotators and giant pieces of plastic are a thing of the past. Unlike older lightbar designs, it's impossible for the center of the FireTech® Omen™ Lightbar to fill with water - It's like a bucket without a bottom. It was designed with a modern exoskeleton and multi-color modules to give the ultimate flexibility while maintaining a super simple design.

SAY GOODBYE TO MOISTURE ISSUES

Moisture is one of the two main killers of lighting products on fire apparatus. Like all FireTech fixtures, mechanically affixed venting mechanisms allow our sealed housings to breathe and remain at a neutral pressure. Moisture problems? Not with the FireTech Omen!

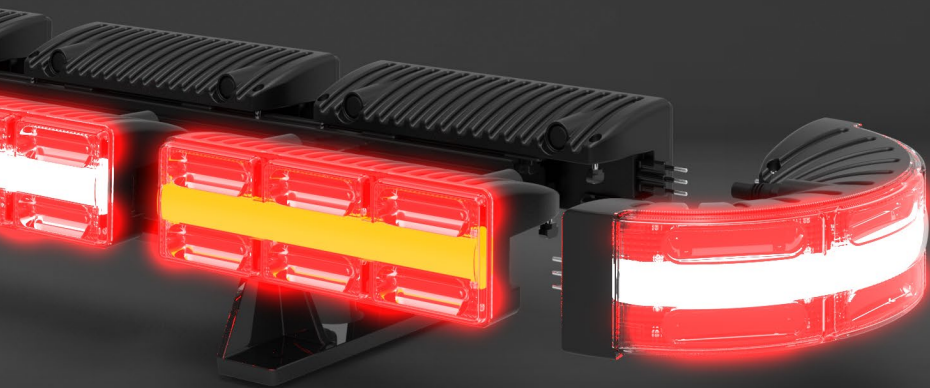

MODULAR DESIGN

The traditional 1980's design lightbar focused on serviceability of internal components. We stepped away from that, building from the ground up to create the first truly modular design using maintenance-free semiconductor tech. With our design, you can configure or replace any size traditional lightbar with the FireTech Omen. If you damage the bar, the modular design also allows you to replace a module rather than the whole fixture - reducing cost and the need for spare parts.



ENJ™

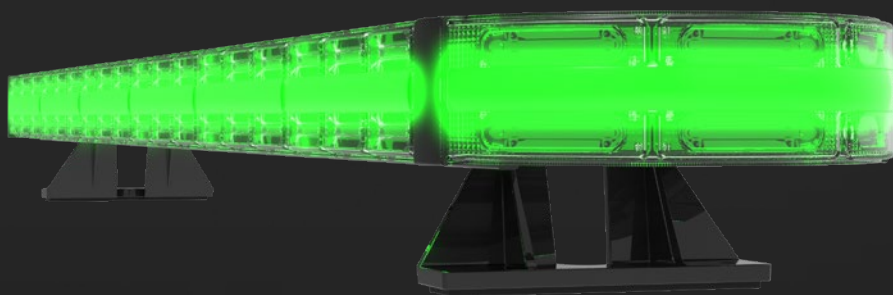

COMMAND ON DEMAND™

Command On Demand functionality turns your lightbar and any fixtures with green LEDs on the apparatus to a steady burning green, indicating command function at the press of a button!

AUTOMATIC NIGHT MODE

Night modes are a hot topic in the fire service today. The Omen Warning Lightbar uses two strategically placed optical sensors to calculate proper intensity. Redundant sensors compare data to prevent false positives and provide more reliable day/night mode selection. The best part? The mode setting is global to all fixtures connected to the system, so no need to program fixtures day/night modes individually!

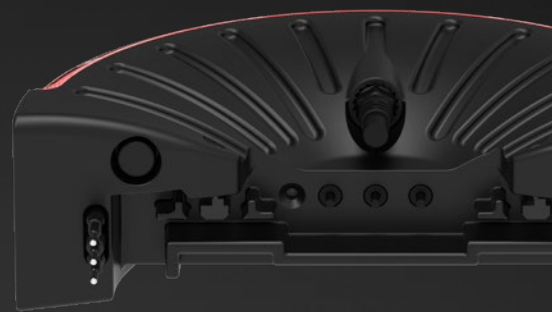

WATER LEVEL OR CHARGE STATUS INDICATOR*

Never get caught unaware of your water levels again.

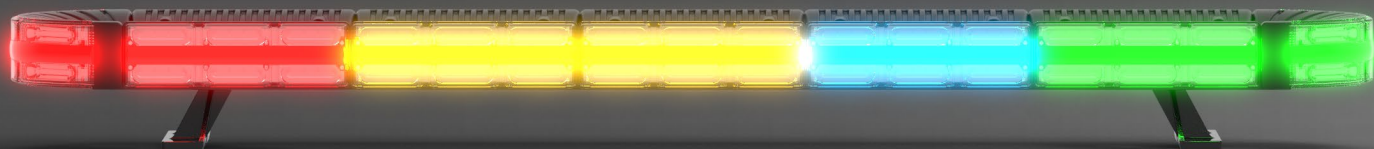

* May require additional hardware, feature to be enabled in future software update



NEW HVC GUARDIAN® WARNING LIGHTS

SURFACE MOUNTED SMART WARNING LIGHTS

KEY FEATURES

- Side Firing LEDs
- Crack-Proof Corners
- Soft Flash user programmable flash patterns
-  Bluetooth® configurability, sync, and control*

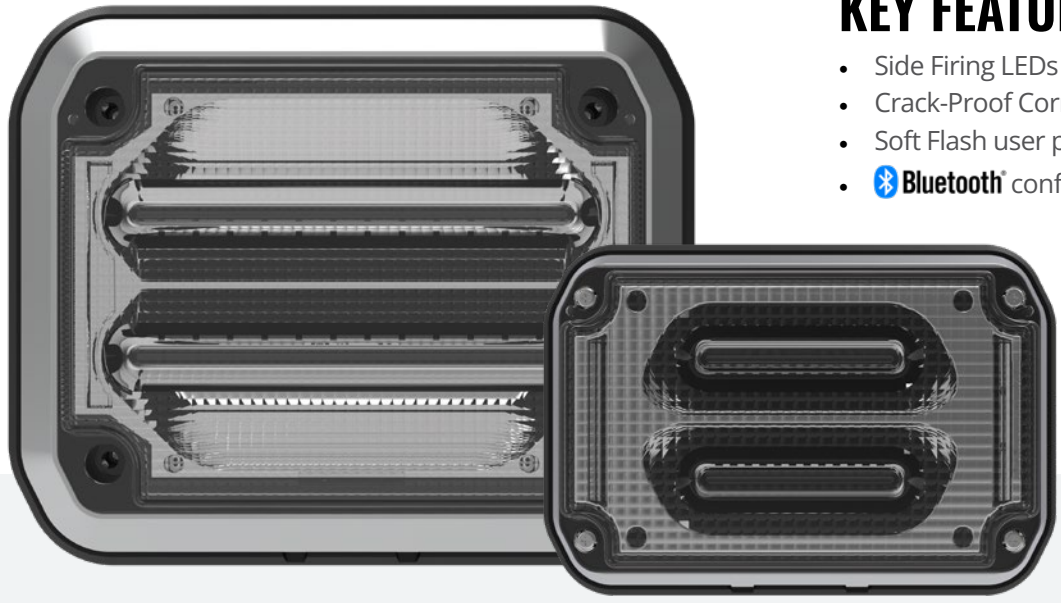

THE ULTIMATE SURFACE MOUNTED WARNING LIGHTS

The HVC Guardian Warning Lights are super durable because they are the only fixtures in their class to feature a full-sized aluminum heat sink, and a lens that never comes in contact with the mounting hardware. Overheated circuitry is the number one killer of LEDs in public safety vehicles and moisture intrusion is a close runner up. With the HiViz Connect™ Guardian Series Warning Lights, you can rest assured we've got both areas covered and, if we're wrong, we will replace the fixture through our industry-leading advance exchange lifetime warranty.

As a bonus, these lights are infinitely updateable with unlimited flash patterns. They also feature forward-facing single or dual color LEDs with chrome reflectors and optical collimators for high intensity light output, plus side-firing LEDs that illuminate the side of the truck which increases its visibility to other drivers.

Part of the magic of this system is that it seamlessly communicates with our smart scene lights. If you're responding, no need for red/white warning lights because the scene lights can act as the white portion of the light. When you get on scene, the white flashing will stop and you can use your scene lights as scene lights.

* Feature coming soon. Device firmware update required.

DIMENSIONS FOR HVC GUARDIAN® WARNING LIGHT

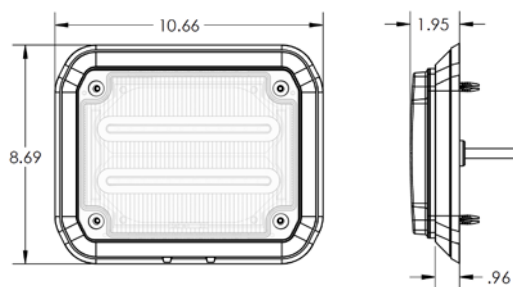

FT-HVC-GSM-WN--LED COLOR**

■ Red ■ Blue ■ Amber ■ RG ■ RB ■ RA

HVC GUARDIAN WARNING LIGHT

DIMENSIONS	10.66" x 8.69" x 1.95"
WEIGHT	4.4 LBS.
BEZEL	CHROME
MAX. WATTAGE	40W
MAX. AMPERAGE	3.1A @ 12V DC
INPUT VOLTAGE DC	11-32V DC
CERTIFICATIONS	SAE W1 J595; NFPA 1900
LED COLOR OPTIONS	RED, BLUE, AMBER, RED/GREEN, RED/BLUE, RED/AMBER

DIMENSIONS FOR HVC GUARDIAN JR WARNING LIGHT

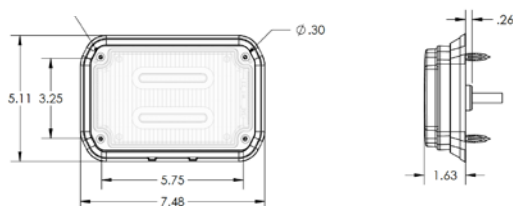

FT-HVC-GSMJR-WN--LED COLOR**

■ Red ■ Blue ■ Amber ■ RG ■ RB ■ RA

HVC GUARDIAN JR WARNING LIGHT

DIMENSIONS	7.48" x 5.11" x 1.63"
WEIGHT	1.7 LBS.
BEZEL	CHROME
MAX. WATTAGE	40W
MAX. AMPERAGE	3.1A @ 12V DC
INPUT VOLTAGE DC	11-32V DC
CERTIFICATIONS	SAE W1 J595; NFPA 1900
LED COLOR OPTIONS	RED, BLUE, AMBER, RED/GREEN, RED/BLUE, RED/AMBER

GUARDIAN & GUARDIAN JR OPTIONAL ACCESSORIES



GUARDIAN RETROFIT GASKET

P/N: P-GSM-RGKIT

For replacing legacy fixtures which may have had a different sized cutout. Covers old or oversized holes in the apparatus body.



GUARDIAN BEZEL DELETE GASKET

P/N: P-GSM-BDKIT

Allows installation of Guardian Warning Light without chrome bezel for a reduced mounting profile.



GUARDIAN BLACKOUT BEZEL

P/N: P-GSM-BOBEZEL

Matte black replacement bezel for FireTech® Guardian Series Product.



GUARDIAN JR. BLACKOUT BEZEL

P/N: P-GSMJR-BOBEZEL

Matte black replacement bezel for FireTech Guardian Jr Series Product.

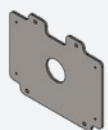

GUARDIAN JR HEADLIGHT AREA MOUNTING BRACKET

P/N: P-4X6-GSMJR-PLATE

Mounting plate for mounting a Guardian Jr Warning Light in a headlight mounting area.

WHY CHOOSE THE GUARDIAN® SERIES?

BACKED BY THE FIRETECH® LIFETIME WARRANTY

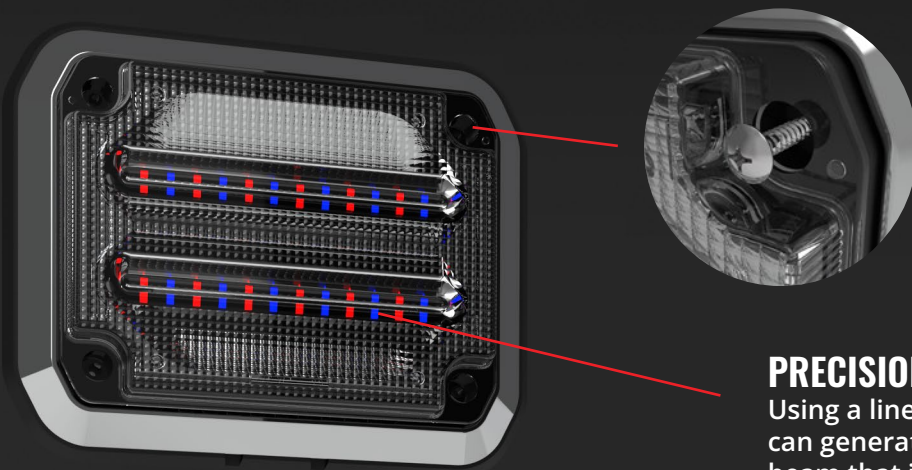

CRACK-FREE CORNER DESIGN

Screws never come in contact with lens, preventing cracking and moisture intrusion. They're so strong you can hang a Hummer from them!

PRECISION LINEAR OPTICS

Using a linear optic this fixture can generate an ultra-wide beam that is visible for miles.

HIGH PERFORMANCE ALUMINUM HEAT SINK

Excessive temperature is the #1 killer of LED products in the public safety industry. Most warning lights are designed with a thin plate of sheet metal behind the LEDs. Instead, we use an oversized aluminum heat sink which keeps the fixture cooler. A cooler fixture means you're less likely to need our warranty. But if you do, we've got your back for life.

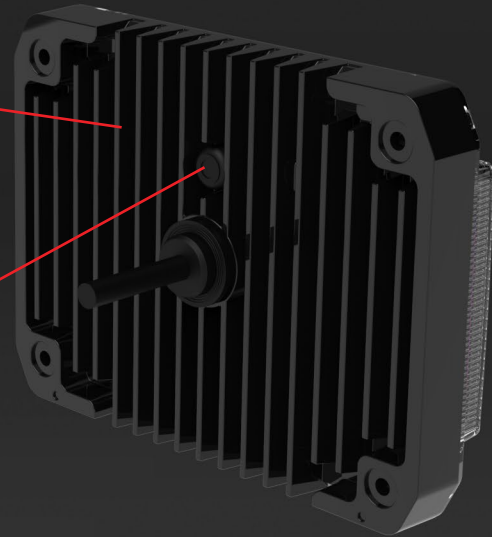

NITTO TEMISH VENT

The second most common killer of LED lights in our industry is moisture. Our Nitto TEMISH Vent allows moisture to vent ensuring no unwanted condensation or water droplets trapped in the lens. Combining crack-proof corners with the TEMISH vent, you can leave your worries at the station.



WIRELESS CONNECTIVITY

Configure features and settings from a smartphone app, or leverage wireless smart synchronization limiting the need to re-run wiring during apparatus retrofit.

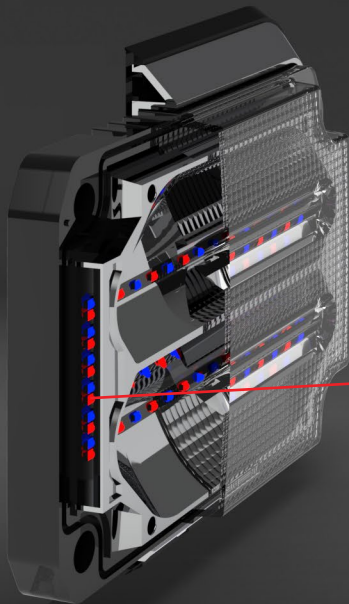

SIDE FIRING LEDs

Viewing angle matters, and more angles means more visibility - especially on windy roads. The HVC Guardian Warning Lights feature both forward-facing LEDs, plus side-firing LEDs that illuminate the side of the truck making the truck more visible to other drivers. Parking off-angle? We've got you covered.



FIRETECH

BY HIVIZ LED LIGHTING

WARNING LIGHTS LIFT H1 HUMMER*

SCAN FOR FULL VIDEO



* ONLY SUITABLE FOR HEAVY DUTY FIRETECH LIGHTS.

DOT LIGHTS





DOT LIGHTS



HRATA

aglave

WARNING
TILT FRONT JACKS
BEFORE TILTING CAB.

WARNING
Check height
before unloading
& loading.
Load evenly.
Clear area of
obstacles.
Park on level
ground.
Use proper tie-down
technique.

WARNING
ALL PINS AND PADS
MUST BE PROPERLY
INSTALLED WHEN
USING STABILIZERS

15



4X6 HEADLIGHTS

PURPOSE BUILT FOR EMERGENCY VEHICLES



KEY FEATURES

- Direct Replacement for Existing Headlights
- Integrated Halo/Park Lamp
- DOT/FMVSS 108 Compliant

DOT COMPLIANT HEADLIGHT FUNCTIONS (4 PIECE KIT EXAMPLE)

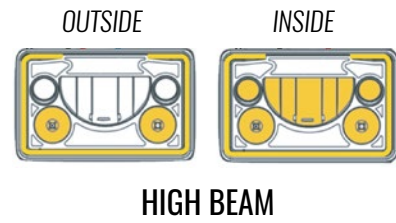
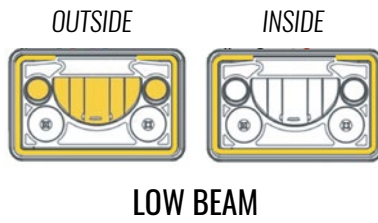
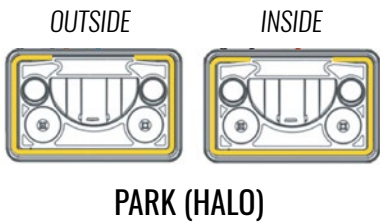

DESIGNED FOR EMERGENCY SERVICES

FireTech® LED headlights are a simple way to dramatically boost the total light output of your emergency vehicle. Utilizing long range IRIS Reflector technology, the FireTech LED headlight is able to push the light from the high beam LEDs to surprising distances, while the reflector for the low beam LED was engineered to produce a wide beam pattern to cover the entire roadway. Each beam is precisely positioned to keep light out of the eyes of traffic, ensuring drivers are unimpaired from the light. Two elliptical beam LEDs in each headlight are aimed to fill in the roadway right in front and to the sides of the vehicle, increasing safety while driving and on scene.

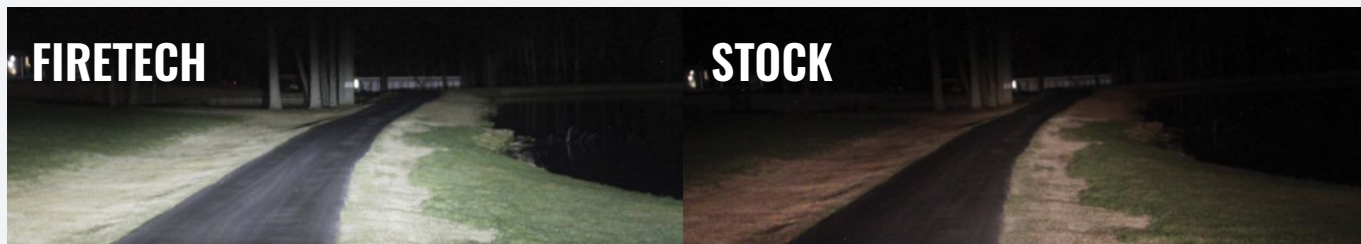



NEW HEATED 4X6 HEADLIGHT

The FireTech® heated LED headlights utilize a heated glass lens which is around 7X more thermally conductive than polycarbonate or other plastics. This lens allows more heat transfer from the heating element to the surface of the lens, which results in faster and more efficient headlight defrosting. The heating element is temperature activated, which prevents it from wearing out during warmer weather conditions. With its durable silver heating element, the headlight is designed for repetitious high temperature cycles in extreme environments.

4X6 HEADLIGHT DIMENSIONS

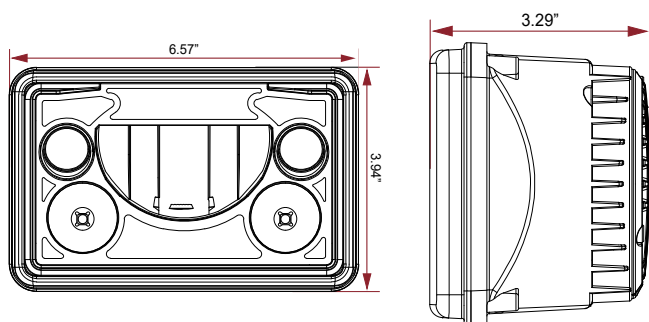

4X6 HEADLIGHTS

USABLE LIGHT	1,000 FEET
REFLECTOR COLORS	CHROME, BLACK CHROME
BEAM MODELS	HIGH/LOW, HALO, HIGH ONLY
DIMENSIONS	6.57" x 3.94" x 3.29"
INPUT VOLTAGE DC	9-32V DC
OPERATING RANGE	-40°F TO +185°F
EMC APPROVAL	CISPR25 CLASS 1
VIBRATION RATING	21.2 G _{RMS}
IP RATING	IP68/69K

MODELS

ITEM #	DESCRIPTION
FT-4X6-HL	4X6 Headlight DOT High / Low (For Low Beam Use); 35W; 2.92A @ 12V DC
FT-4X6-HL-DB	4X6 Headlight DOT High / Low (For Low Beam Use), Black Chrome; 35W; 2.92A @ 12V DC
FT-4X6-H	4X6 Headlight DOT High Beam Only; 41W; 3.42A @ 12V DC
FT-4X6-4KIT	4X6 Kit Containing 4 Headlights: 2 High/Low & 2 High Only; 152W; 12.67A @ 12V DC
FT-4X6-4KIT-DB	4X6 Kit Containing 4 Headlights: 2 High/Low & 2 High Only, Black Chrome; 152W; 12.67A @ 12V DC
FT-4X6-HL-KIT	4X6 Kit Containing 2 High / Low Headlights; 70W; 5.83A @ 12V DC
FT-4X6-HL-DF	Heated 4X6 Headlight DOT High / Low (For Low Beam Use); 58W; 4.84A @ 12V DC
FT-4X6-H-DF	Heated 4X6 Headlight DOT High Beam Only; 64W; 5.37A @ 12V DC
FT-4X6-4KIT-DF	Heated 4X6 Kit Containing 4 Headlights: 2 High / Low & 2 High Only; 244W; 20.42A @ 12V DC
FT-4X6-HL-KIT-DF	Heated 4X6 Kit Containing 2 High / Low Headlights; 116W; 9.68A @ 12V DC



5.75" & 7" HEADLIGHTS

PURPOSE BUILT FOR EMERGENCY VEHICLES



KEY FEATURES

- Direct Replacement
- Integrated Park Lamp Halo
- FMVSS 108 / DOT Compliant

DOT COMPLIANT HEADLIGHT FUNCTIONS (4 PIECE KIT EXAMPLE)

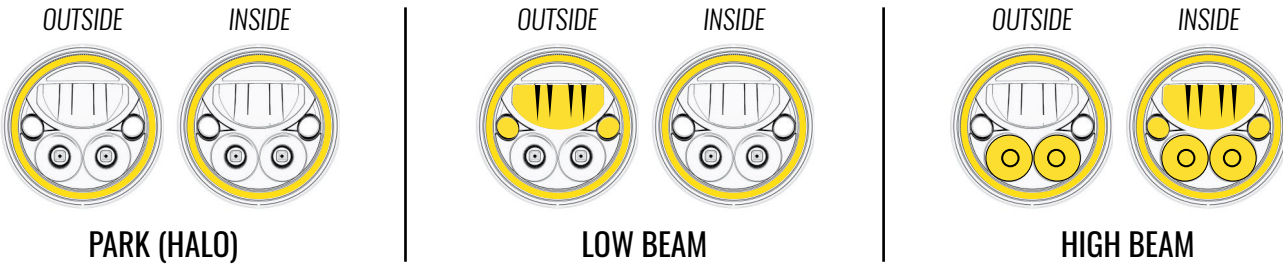



5.75" HEADLIGHT DIMENSIONS

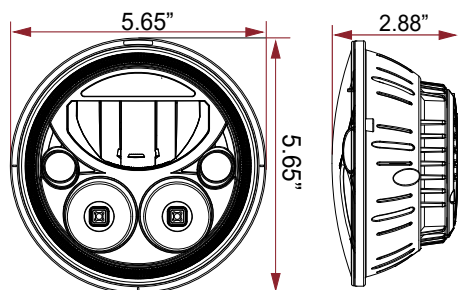

5.75" HEADLIGHTS

RAW LUMENS	4,210/EA
BEAM MODELS	HIGH/LOW, HALO, HIGH ONLY
DIMENSIONS	5.65" x 5.65" x 2.88"
WATTAGE	41W
AMP DRAW (@12V)	3.42A
INPUT VOLTAGE DC	9-32V DC

7" HEADLIGHT DIMENSIONS

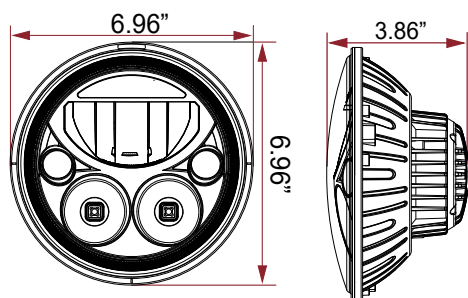

7" HEADLIGHTS

RAW LUMENS	4,210/EA
BEAM MODELS	HIGH/LOW, HALO, HIGH ONLY
DIMENSIONS	6.96" x 6.96" x 3.86"
WATTAGE	37W
AMP DRAW (@12V)	2.92A
INPUT VOLTAGE DC	9-32V DC

**LEARN MORE ABOUT
FIRETECH HEADLIGHTS**

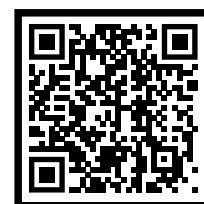

MODELS

ITEM #	DESCRIPTION
FT-575RD-H	5.75" Headlight DOT High Only; 34.2W; 2.67A @ 12V DC
FT-575RD-HL	5.75" Headlight DOT High / Low (For Low Beam Use); 30.2W; 2.35A @ 12V DC
FT-575RD-HL-KIT	5.75" Kit Containing 2 High / Low Headlights; 60.4W; 4.7A @ 12V DC
FT-575RD-4KIT	5.75" Kit Containing 4 Headlights, 2 High/Low and 2 High Only; 128.8W; 10.04A @ 12V DC
FT-575RD-H-MOUNT	Mounting Kit for 5.75" Headlight DOT High Only; 34.2W; 2.67A @ 12V DC
FT-575RD-HL-MOUNT	Mounting Kit for 5.75" Headlight DOT High / Low (For Low Beam Use); 30.2W; 2.35A @ 12V DC
FT-575RD-HL-KIT-MOUNT	Mounting Kit for 5.75" Kit Containing 2 High / Low Headlights; 60.4W; 4.7A @ 12V DC
FT-575RD-4KIT-MOUNT	Mounting Kit for 5.75" Kit Containing 4 Headlights, 2 High/Low and 2 High Only; 128.8W; 10.04A @ 12V DC
FT-7RD-HL	7" Headlight DOT High / Low (For Low Beam Use); 47W; 3.67A @ 12V DC
FT-7RD-HL-KIT	7" Headlight Kit of 2 DOT High / Low (For Low Beam Use); 94W; 7.34A @ 12V DC

BRACKETS
REQUIRED TO
MOUNT ON
PIERCE CABS



NEW GUARDIAN® JR TAIL LIGHT ASSEMBLY

PURPOSE BUILT FOR EMERGENCY VEHICLES

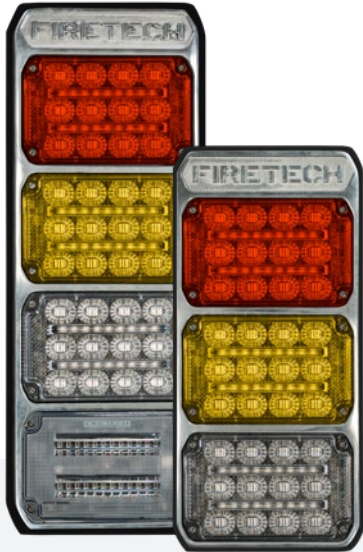

KEY FEATURES

- Same Industry-Standard Footprint and Bolt Patterns as Legacy Technology Produced by Other Manufacturers
- DOT Compliant Tail Light Modes
- Can Be Purchased in Kits or Individual Fixtures



2 Flash Patterns

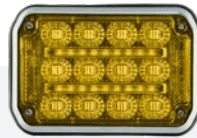

7 Flash Patterns

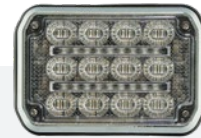

On / Off

STOP/TAIL, TURN, BACKUP LIGHTS

The Guardian® Jr Stop/Tail, Turn, and Backup lights are an expansion of the Guardian series of fixtures. They can be purchased individually (Stop/Tail, Turn, or Backup), or can be purchased in kits with triple and quad tail light housings. These fixtures are an economical addition to your apparatus which allows you to choose all fixtures from one lighting manufacturer for your whole apparatus, all backed by the industry's first Lifetime Advance Exchange replacement warranty.

DIMENSIONS FOR QUAD, TRIPLE, SINGLE, & NO BEZEL ASSEMBLIES

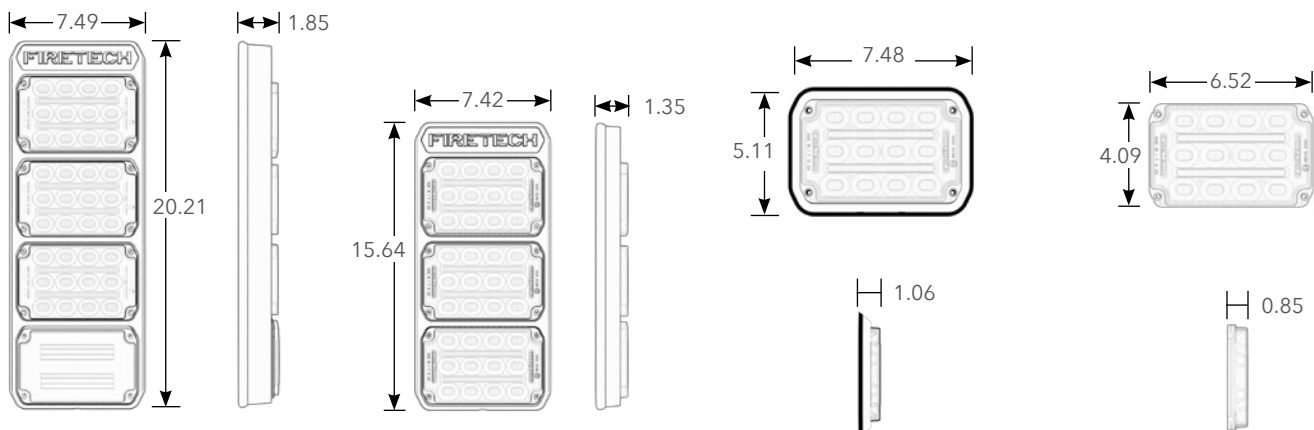

GUARDIAN JR STOP/TAIL, TURN, BACKUP LIGHTS



STOP/TAIL LIGHT | FT-TL-GSMJR-STT

DIMENSIONS	6.52" x 4.09" x 0.85"
AVG. WATTAGE (TAIL)	1.32W
MAX. WATTAGE (TAIL)	2.64W
MAX. WATTAGE (STOP)	2.88W
AVG. AMPERAGE (TAIL)	0.11A @ 12V DC; 0.06A @ 24V DC
MAX. AMPERAGE (TAIL)	0.22A @ 12V DC; 0.11A @ 24V DC
MAX. AMPERAGE (STOP)	0.24A @ 12V DC; 0.12A @ 24V DC
INPUT VOLTAGE DC	10-32V DC
CERTIFICATIONS	FMVSS-108; SAE J2040; SAE J585; IP67 & IP69K

BACKUP LIGHT | FT-TL-GSMJR-BACKUP

DIMENSIONS	6.52" x 4.09" x 0.85"
MAX. WATTAGE	2.88W
MAX. AMPERAGE	0.24A @ 12V DC; 0.12A @ 24V DC
INPUT VOLTAGE DC	10-32V DC
CERTIFICATIONS	FMVSS-108; SAE J593; IP67 & IP69K

TURN LIGHT | FT-TL-GSMJR-TURN

DIMENSIONS	6.52" x 4.09" x 0.85"
AVG. WATTAGE	1.44W
MAX. WATTAGE	2.88W
AVG. AMPERAGE	0.12A @ 12V DC; 0.06A @ 24V DC
MAX. AMPERAGE	0.24A @ 12V DC; 0.12A @ 24V DC
INPUT VOLTAGE DC	10-32V DC
CERTIFICATIONS	FMVSS-108; SAE J2261; SAE J588; IP67 & IP69K

MODELS

ITEM #	DESCRIPTION
FT-TL-GSMJR-STT	Guardian JR Stop/Tail Light. Red Lens. Red LEDs. Dim Running Light, Bright Stop Light.
FT-TL-GSMJR-BACKUP	Guardian JR Backup Light. Clear Lens. White LEDs. On/Off White Light.
FT-TL-GSMJR-TURN	Guardian JR Turn Signal Light. Amber Lens. Amber LEDs. Arrow and Other Functions.
FT-TL-GSMJR-6KIT	Complete Set of 2 Stop/Tail Lights, 2 Turn Lights, and 2 Backup Lights. Includes 6 Chrome Bezels.
FT-TL-GSMJR-TRIPLE-KIT	Complete Set of 2 Triple Tail Light Housings. Includes Stop/Tail, Turn, and Backup Lights.
FT-TL-GSMJR-QUAD-KIT	Complete Set of 2 Quad Tail Light Housings. Includes Stop/Tail, Turn, and Backup Lights.
FT-TL-GSMJR-QUAD-KIT-RED	Complete Set of 2 Quad Tail Light Housings. Includes Stop/Tail, Turn, Backup, and Red Guardian Jr Warning Lights.
FT-TL-GSMJR-QUAD-KIT-AMBER	Complete Set of 2 Quad Tail Light Housings. Includes Stop/Tail, Turn, Backup, and Amber Guardian Jr Warning Lights.
FT-TL-GSMJR-QUAD-KIT-BLUE	Complete Set of 2 Quad Tail Light Housings. Includes Stop/Tail, Turn, Backup, and Blue Guardian Jr Warning Lights.
FT-TL-HVC-GSMJR-QUAD-KIT-RED	Complete Set of 2 Quad Tail Light Housings. Includes Stop/Tail, Turn, Backup, and Red "Smart" Guardian Jr Warning Lights.
FT-TL-HVC-GSMJR-QUAD-KIT-AMBER	Complete Set of 2 Quad Tail Light Housings. Includes Stop/Tail, Turn, Backup, and Amber "Smart" Guardian Jr Warning Lights.
FT-TL-HVC-GSMJR-QUAD-KIT-BLUE	Complete Set of 2 Quad Tail Light Housings. Includes Stop/Tail, Turn, Backup, and Blue "Smart" Guardian Jr Warning Lights.
P-GSMJR-BEZEL	1 Chrome Bezel.
P-GSMJR-BOBEZEL	1 Blackout Bezel.
P-GSMJR-BEZELKIT	1 Chrome Bezel with Foam Perimeter Gasket and Mounting Hardware.
P-GSMJR-BOBEZELKIT	1 Blackout Bezel with Foam Perimeter Gasket and Mounting Hardware.
FT-TL-GSMJR-TRIPLE-HO	Individual Triple Bezel Kit with Foam Perimeter Gasket and Mounting Hardware.
FT-TL-GSMJR-QUAD-HO	Individual Quad Bezel Kit with Foam Perimeter Gasket and Mounting Hardware.

BAR-STYLE FIXTURES





BAR-STYLE FIXTURES



BG2 SMART (BG2S) MODULAR LIGHT SYSTEM

REVOLUTIONARY MODULAR LIGHTING TECHNOLOGY

BG2S KEY FEATURES

The race for the most light is over. In today's digitally connected world full of distracted drivers, it's more important to use the right type of light in only the correct areas. With the BG2S, every module has the ability to engage spot, flood, scene, or colored lights independently. This means you can focus on the big picture of the scene and control the white lighting, warning lighting, and traffic director functions from one interconnected system.

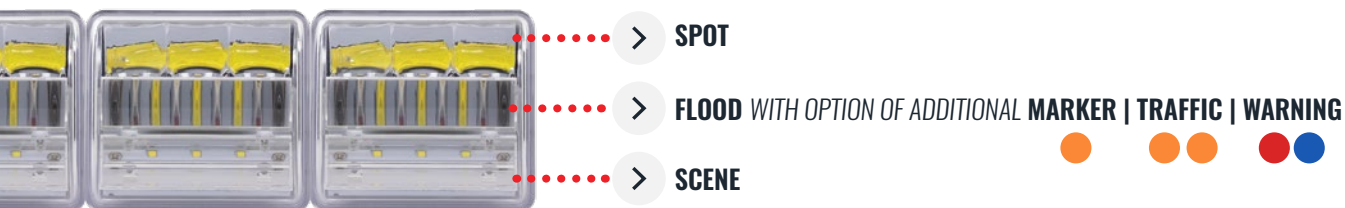

MARKER LIGHT OPTION

Add an additional circuit with amber LEDs to select modules to function as marker lights (available with all BG2S lighting packages).



TRAFFIC DIRECTOR OPTION

Add an array of amber LED circuits to your BG2S to create a synchronized traffic indicator across a single (Smart) or multiple (Smart Multi-System) BG2 light fixtures available with Smart and Smart Multi-System BG2 lighting packages.

OR



WARNING LIGHT OPTION

Add an array of colored (red, blue, or amber) LED circuits to your BG2S to create a synchronized warning light across a single (Smart) or multiple (Smart Multi-System) BG2S light fixtures (available with Smart and Smart Multi-System BG2 lighting packages).

GLOW MODE

Engages the scene BG2S lighting circuit to produce a soft, downward facing glow that is suitable for non-mission critical service calls (available on any smart fixture or system).

GO MODE

Engages spot, flood, and scene BG2S lighting circuits simultaneously with MAX intensity that is suitable for mission critical service calls (available on any smart fixture or system).

CRUISE MODE

Engages colored LED circuit only with low-intensity (available with Multi-System BG2S Package only).

DIMENSIONS

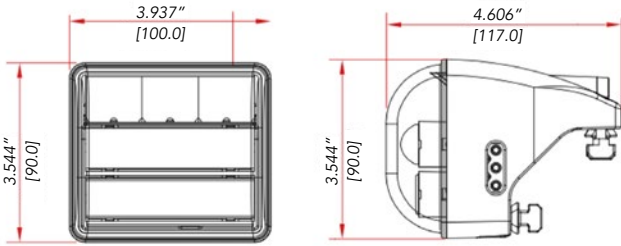

BG2S 4" MODULE

VOLTAGE RANGE	9-32V DC
MAX POWER CONSUMPTION	32 WATTS
RAW LUMENS PER MODULE	3,400
OPERATING TEMP. RANGE	-40°C TO 60°C
INGRESS PROTECTION RATING	IP67/69K
DIMENSIONS	3.544" x 3.937" x 4.606"

EXPANDABLE MODULAR DESIGN

The building block and backbone for this system is a 4" wide light module with a variety of circuits packed inside. Each module is attached to a custom extrusion and shares power through our innovative bridging pin connectors. The modular design allows for sizes ranging from a single module wide up to the full length of the apparatus.



CUSTOM TOOLED MOUNTING BRACKET FOR ANY CAB

The key to minimizing shadowing is correct placement on the apparatus. With BG2S, a custom-tooled extrusion is matched to the installation location, which results in optimal placement on the edge of the apparatus body. No fabricating, cutting, or thinking are required. Just choose the correct extrusion, mount the track, and send the truck down the road. Choose your chassis brand:

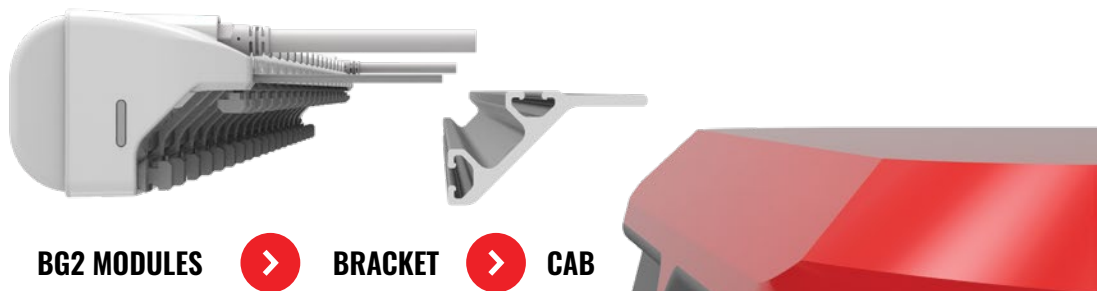

BG2 MODULES



BRACKET



CAB



BG2S USER INTERFACE PANEL (UIP)

CUSTOMIZABLE LIGHTING CONFIGURATIONS

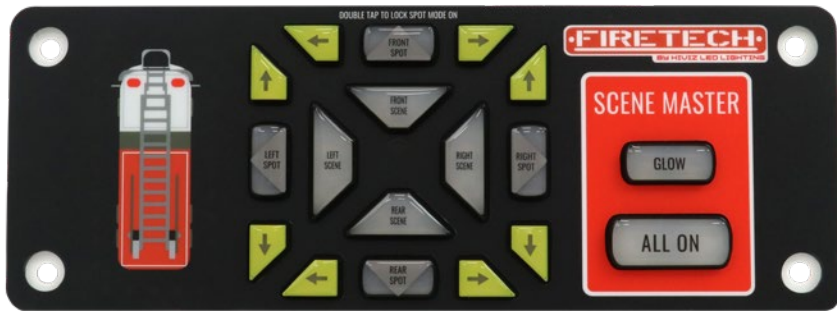

FT-BG2S-UIP-001

KEY FEATURES

- Control a Full Truck of BG2S Lights from One Panel
- Install Multiple Panels to Control System From Multiple Locations
- Active Load Management
- Software Configurable

THE ULTIMATE CONTROL PANEL

The BG2 Smart lighting system is a solution for firefighters that makes it easier and faster to get lights on the scene. It uses optically grouped fixtures, one switch panel location, and customizable button panels to help rapidly put light in any area around the truck. You can have up to four User Interface Panels installed in different areas of the truck so you can easily adjust the lighting no matter where you are on the truck.

Active load management is a unique feature of BG2S systems that ensures the alternator's power matches the amount of power being drawn from the battery. This prevents the truck from shutting off and having to work in the dark. The User Interface Panel senses the amount of power being drawn and will dim the lights when necessary.

OTHER BG2S CONTROLLER OPTIONS

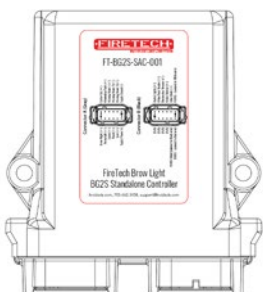

STANDALONE CONTROLLER

P/N: FT-BG2S-SAC-001

When you are using a single BG2S fixture, the Standalone Controller gives you the ability to control the fixture using 13 pre-selected input pins.

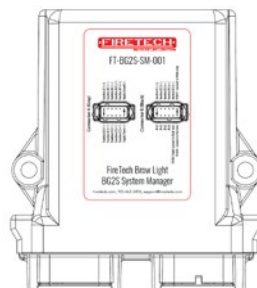

SYSTEM MANAGER

P/N: FT-BG2S-SM-001

When controlling multiple BG2S fixtures on one truck, a single System Manager connects to all of the fixtures and gives you the ability to program up to 13 user-selectable system inputs.

DIMENSIONS

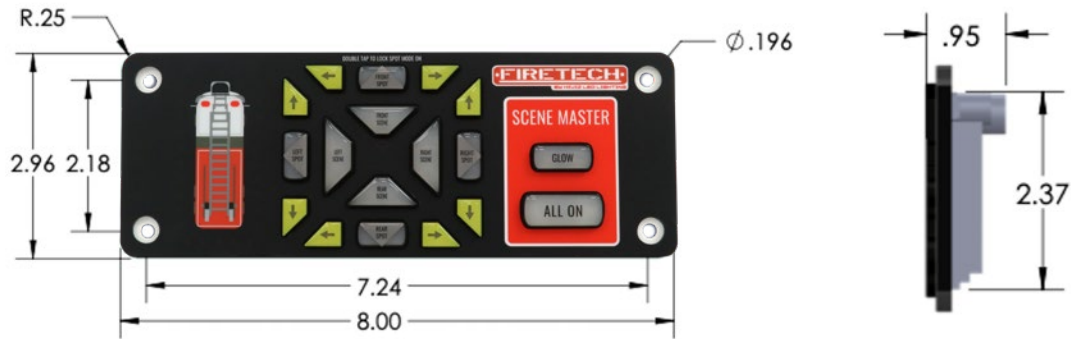

ULTIMATE CONTROL USER INTERFACE PANEL

- » Eliminates hassle of apparatus electrical integration.
- » Quickly change between all lighting modes across multiple light fixtures.
- » Sync multiple panels together to control system from more than one location.



BG2S USER INTERFACE PANEL IN HOUSING
FT-BG2S-UIP-001-MOUNT

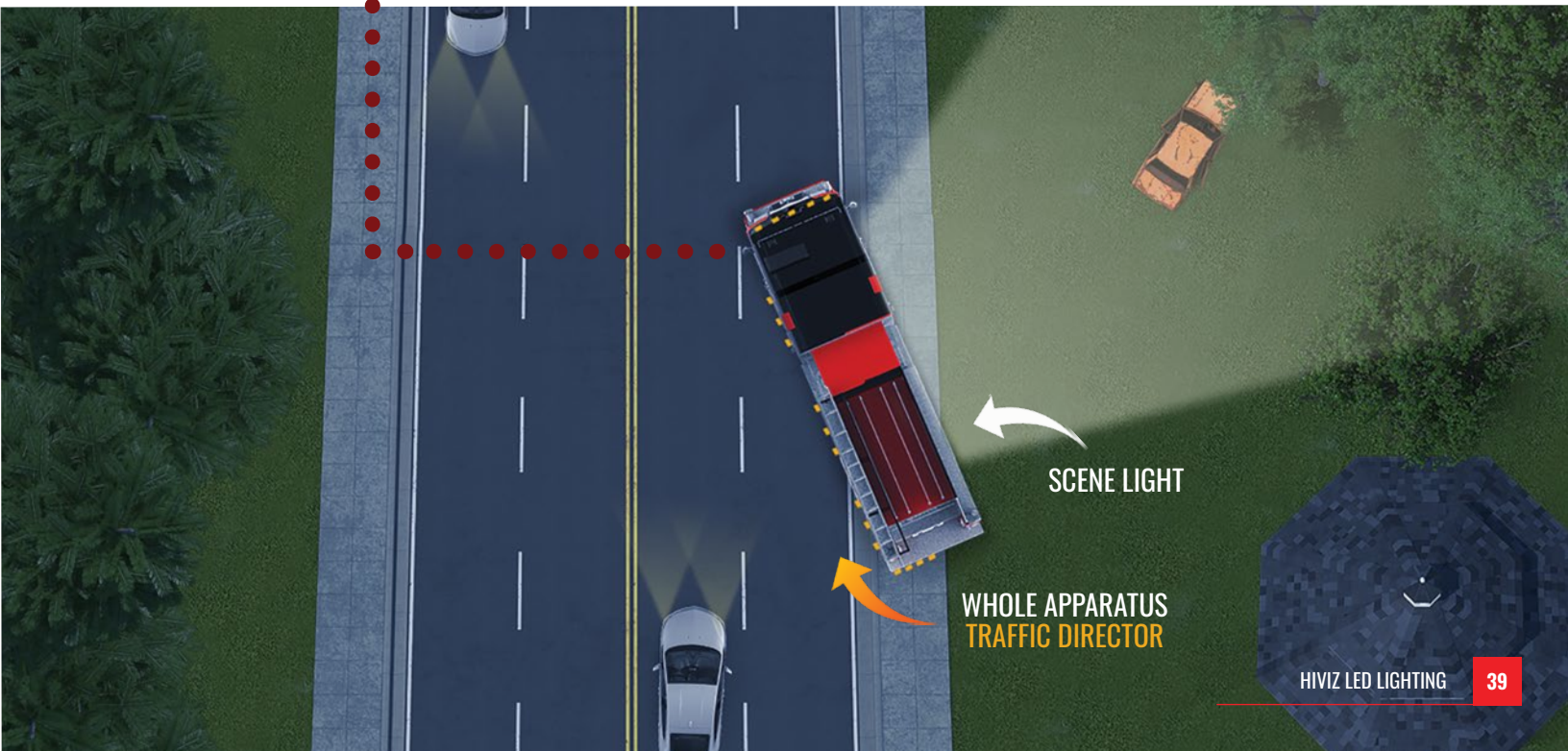



BROW LIGHTS

4"-75" LOW PROFILE LIGHT FIXTURES



KEY FEATURES

- **OPTIONAL MARKER LIGHTS (DOT COMPLIANT)**

Each FireTech® Brow Light has the option of integrated DOT compliant marker lights. These allow you to combine six to seven fixtures into one, while maintaining DOT compliance.

- **ADJUSTABLE MOUNTS ALONG BODY**

Using our patented rail mounting foot, the FireTech brow lights can be securely attached to the cab every 12-18 inches, preventing the housing from flexing and preserving fixture integrity over time.

- **ALL ALUMINUM CONSTRUCTION**

FireTech Brow Lights are manufactured from a solid billet of aluminum which offers superior structural rigidity and thermal dissipation.

DOMINATE THE SCENE WITH FIVE LIGHTS IN ONE

FireTech Brow Lights give you the right type of lighting for the leading edge of your apparatus cab. By combining a long distance spot beam with multiple flood beams, your apparatus will have both range and coverage.

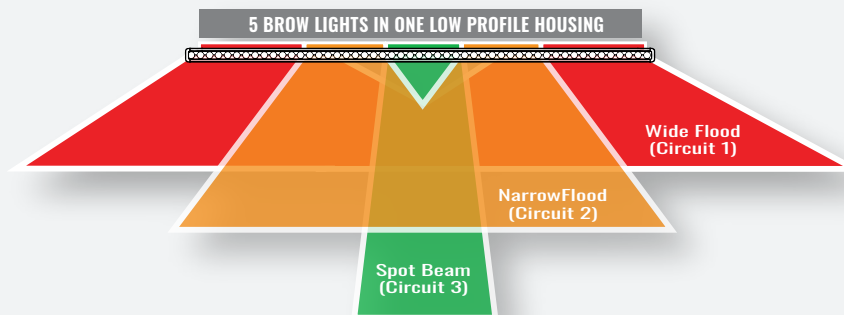



STANDARD BROW LIGHT MODELS

- FT-B-46-* | 36 LEDs | 19,008 RAW LM**

46"
- FT-B-50-* | 39 LEDs | 20,592 RAW LM**

50"
- FT-B-54-2PKIT-* | 42 LEDs | 22,176 RAW LM**

54"
- FT-B-65-* | 51 LEDs | 26,928 RAW LM**

65"
- FT-B-72-* | 57 LEDs | 30,096 RAW LM**

73"
- FT-B-72-3PKIT-* | 57 LEDs | 30,096 RAW LM**

79"

MARKER BROW LIGHT MODELS

- FT-B-46-ML-* | 35 LEDs | 15,840 RAW LM**

45"
- FT-B-46-ML3-* | 39 LEDs | 19,008 RAW LM**

50"
- FT-B-72-ML-* | 59 LEDs | 28,512 RAW LM** *80" AVAILABLE ON REQUEST FOR EXTRA LARGE CABS*

75"
- FT-B-72-ML-3PKIT-* | 59 LEDs | 28,512 RAW LM**

79"

DIMENSIONS

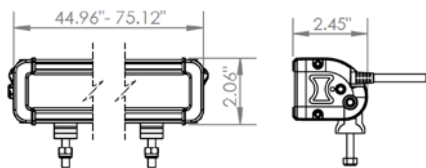

HiViz CONNECT™

NEW Now available with HiViz Connect™ smart functionality:

P/N: FT-HVC-B-72-ML
&
P/N: FT-HVC-B-80-ML

ITEM #	DESCRIPTION	ACTUAL LENGTH
FT-B-46-ML-*	46" Brow Light, 5 integrated marker lights, 4 circuits	44.96"/1,142.40mm
FT-B-46-ML3-*	46" Brow Light, 3 integrated marker lights, 4 circuits	50.01"/1,270.25mm
FT-B-50-*	50" Brow Light, 3 circuits	50.02"/1,270.51mm
FT-B-54-2PKIT-*	2 Piece 54" Brow Light, single circuit for aerials	2x 27.33"
FT-B-65-*	65" Brow Light, 3 circuits	65.23"/1,656.80mm
FT-B-72-*	72" Brow Light, 3 circuits	72.69"/1,846.33mm
FT-B-72-ML-*	72" Brow Light, 5 integrated marker lights, 4 circuits	75.12"/1,908.05mm
FT-B-72-ML-3PKIT-*	3 Piece 72" Brow Light with marker lights for radiused cabs	1x 27.32" 2x 24.8"
FT-B-72-3PKIT-*	3 Piece 72" Brow Light for radiused cabs	1x 27.32" 2x 23.52"

* - Housing Color Options: "B" - Black, "W" - White



SINGLE STACK MINIBROW®

4"-50" MINIBROW SCENE LIGHTS



KEY FEATURES

- Ultra Low Profile Design
- Configurable Optics
- Adjustable Mounting Rail

MODELS

5"	FT-MB-3-**-* 3 LEDs 1,584 RAW LM	27"	FT-MB-21-**-* 21 LEDs 11,088 RAW LM
8"	FT-MB-6-**-* 6 LEDs 3,168 RAW LM	31"	FT-MB-24-**-* 24 LEDs 12,672 RAW LM
12"	FT-MB-9-**-* 9 LEDs 4,752 RAW LM	35"	FT-MB-27-**-* 27 LEDs 14,256 RAW LM
20"	FT-MB-15-**-* 15 LEDs 7,920 RAW LM	42"	FT-MB-33-**-* 33 LEDs 17,424 RAW LM

DIMENSIONS

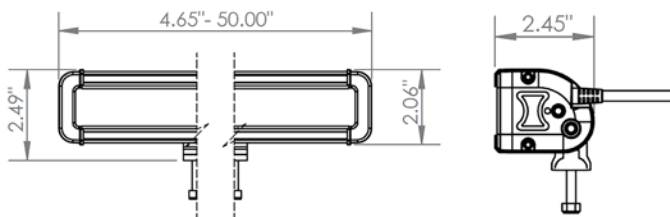

ITEM #	ACTUAL LENGTH	WATTS	AMP DRAW
FT-MB-3-**-*	4.65"	15	1.25
FT-MB-6-**-*	8.43"	30	2.5
FT-MB-9-**-*	12.21"	45	3.75
FT-MB-15-**-*	19.77"	75	6.25
FT-MB-21-**-*	27.33"	105	8.75
FT-MB-24-**-*	31.11"	120	10
FT-MB-27-**-*	34.89"	135	11.25
FT-MB-33-**-*	42.44"	165	13.75
FT-MB-39-**-*	50.00"	195	16.25

** - Optic Options: "S" - Spot, "F" - Flood, "FT" - Combo Optics
 * - Housing Color Options: "B" - Black, "W" - White



DOUBLE STACK MINIBROW®

4"-50" MINIBROW SCENE LIGHTS



KEY FEATURES

- Two Rows of LEDs
- Configurable Optics
- Adjustable Mounting Rail

DIMENSIONS

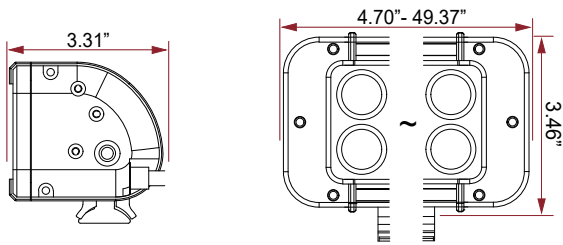

ITEM #	ACTUAL LENGTH	WATTS	AMP DRAW
FT-MB-2.3-**-*	4.70"	30	2.5
FT-MB-2.6-**-*	7.90"	60	5
FT-MB-2.9-**-*	11.10"	90	7.5
FT-MB-2.15-**-*	17.50"	150	12.5
FT-MB-2.18-**-*	20.60"	180	15
FT-MB-2.27-**-*	30.20"	270	22.5
FT-MB-2.36-**-*	39.80"	360	30
FT-MB-2.45-**-*	49.37"	450	37.5

** - Optic Options: "S" - Spot, "F" - Flood, "FT" - Combo Optics

* - Housing Color Options: "B" - Black, "W" - White

MODELS

FT-MB-2.3-**-* | 6 LEDs | 3,168 RAW LM



FT-MB-2.6-**-* | 12 LEDs | 6,336 RAW LM



FT-MB-2.9-**-* | 18 LEDs | 9,504 RAW LM



FT-MB-2.15-**-* | 30 LEDs | 15,840 RAW LM



FT-MB-2.18-**-* | 36 LEDs | 19,008 RAW LM



FT-MB-2.27-**-* | 54 LEDs | 28,512 RAW LM



FT-MB-2.36-**-* | 72 LEDs | 38,016 RAW LM



FT-MB-2.45-**-* | 90 LEDs | 47,520 RAW LM





TRUNNION MINIBROW®

14"-31" MINIBROW SCENE LIGHTS



KEY FEATURES

- Ultra Low Profile Design
- Configurable Optics
- Adjustable Mounting Rail

MODELS

FT-MB-9-TR-**-* | 9 LEDs | 4,752 RAW LM



FT-MB-12-TR-**-* | 12 LEDs | 6,336 RAW LM



FT-MB-18-TR-**-* | 18 LEDs | 9,504 RAW LM



FT-MB-24-**-*-GWA0011 | 24 LEDs | 12,672 RAW LM



NOTE: The "TRGWA" style Trunnion is only Available on FT-MB-24 Model

60 POINT LOCKING AIMING SYSTEM

The sturdy trunnion bracket allows the MiniBrow to be precisely aimed regardless of mounting location. Enjoy full rotation flexibility from an ultra low profile housing.

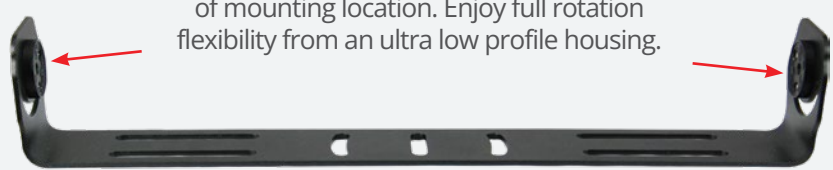

DIMENSIONS

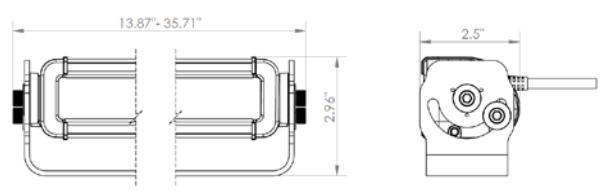

ITEM #	LENGTH	WATTS	AMP DRAW
FT-MB-9-TR-**-*	13.87"	45	3.75
FT-MB-12-TR-**-*	17.65"	60	5.0
FT-MB-18-TR-**-*	25.20"	90	7.5
FT-MB-24-**-*-GWA0011	31.11"	120	10.0

** - Optic Options: "S" - Spot, "F" - Flood, "FT" - Combo Optics

* - Housing Color Options: "B" - Black, "W" - White



MOUNTING ACCESSORIES

OPTIONS FOR YOUR LIGHTBARS

OPTIONAL MOUNTING ACCESSORIES

CAB MOUNTING BRACKET | 3" RADIUS SURFACE

For use with any brow light

BLACK: P-MB-R3V2FOOT-B

WHITE: P-MB-R3V2FOOT-W

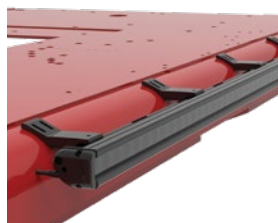

L-FOOT BRACKET | VERTICAL SURFACE

For use with any brow light

BLACK: P-MB-LFOOT-B

WHITE: P-MB-LFOOT-W



END CAP BRACKET | FLAT SURFACE

For use with brow lights 36" or less only

MINIBROW BLACK: FT-MBKIT-LPX-B

MINIBROW WHITE: FT-MBKIT-LPX-W

DOUBLE MINIBROW BLACK: FT-MBKIT-PX-B

DOUBLE MINIBROW WHITE: FT-MBKIT-PX-W

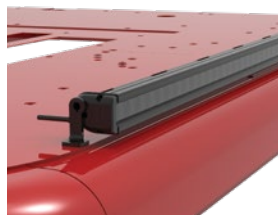

J-FOOT BRACKET | MOUNT TO WARNING LIGHTBAR

Attaches a traditional FireTech brow light or MiniBrow light directly to the Omen warning lightbar, only available in black

BLACK: FT-MB-JFOOT-B



LICENSE | MOUNT TO WARNING LIGHTBAR

For use with a FT-MB-9 to license plate of nearly any vehicle

LIGHT AND BRACKET: FT-MB-9-LP-**-*

BRACKET ONLY: FT-LPBRKT



SURFACE & RECESSED SCENE LIGHTS





SURFACE & RECESSED SCENE LIGHTS





GUARDIAN® SERIES

SURFACE MOUNTED SCENE LIGHTS



KEY FEATURES

- Industry Standard Sizes
- Multiple Output Options
- Widespread Precision Optics

MORE LIGHT WHILE DRAWING LESS POWER

The Guardian Elite produces as much measurable light as other fixtures in the fire industry that advertise 20,000 lumens of output. However, the Guardian Elite produces that light using close to 90 watts (7.5A) LESS power per fixture, at 12V DC. What does this mean for you? In the world of modern electronics, the capacity of the 12V chassis electrical system is often quickly consumed. When building a truck with lots of DC loads, you will be less likely to experience amperage load chart or electrical system limitations due to the scene lighting package using an ultra-efficient fixture like the FireTech® Guardian Elite!

Less Power = Less Heat. By keeping the circuit temperature low, the FireTech Guardian Series can offer sustained light output regardless of runtime on your incident.

GUARDIAN OPTIONAL ACCESSORIES



RETROFIT GASKET
P/N: P-GSM-RGKIT

For replacing older style fixture or halogen side scene light. Covers old or oversized holes in the body.



BEZEL DELETE GASKET
P/N: P-GSM-BDKIT

Allows installation of Guardian/Guardian Elite Scene Light without chrome bezel for a reduced mounting profile.

DIMENSIONS FOR GUARDIAN® AND GUARDIAN ELITE

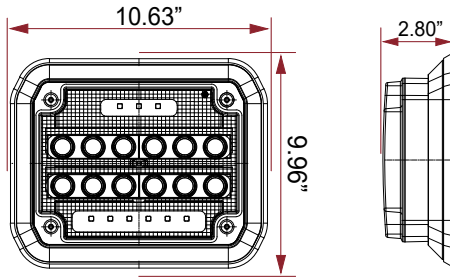

HiViz CONNECT™

NEW Now available with HiViz Connect™ smart functionality:
P/N: FT-HVC-GESM-*

GUARDIAN | STANDARD OUTPUT

RAW LUMENS	10,000
EFFECTIVE LUMENS	6,500
OPT. HOUSING COLORS	BLACK OR WHITE
WATTAGE	75W
AMP DRAW (@12V)	5.83A
INPUT VOLTAGE DC	9-32V DC

GUARDIAN ELITE | HIGH OUTPUT

RAW LUMENS	20,500
EFFECTIVE LUMENS	12,290
OPT. HOUSING COLORS	BLACK OR WHITE
WATTAGE	120W
AMP DRAW (@12V)	10.41A
INPUT VOLTAGE DC	9-32V DC

DIMENSIONS FOR GUARDIAN JR | FT-GSMJR

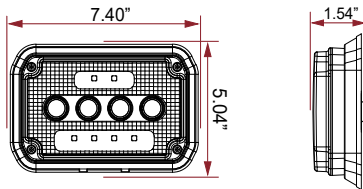

HiViz CONNECT™

NEW Now available with HiViz Connect smart functionality:
P/N: FT-HVC-GSMJR-*

GUARDIAN JR | STANDARD OUTPUT

RAW LUMENS	5,000
EFFECTIVE LUMENS	3,125
OPT. HOUSING COLORS	BLACK OR WHITE
DIMENSIONS	7.40" x 5.04" x 1.54"
WATTAGE	35W
AMP DRAW (@12V)	3.33A
INPUT VOLTAGE DC	9-32V DC

MODELS

ITEM #	DESCRIPTION
FT-GSM	Guardian LED Surface Mount: 10K lm, DC Power, 75W, Chrome
FT-GSM-B	Guardian LED Surface Mount: 10K lm, DC Power, 75W, Black
FT-GESM	Guardian Elite LED Surface Mount: 20.5K lm, DC Power, 120W, Chrome
FT-GESM-B	Guardian Elite LED Surface Mount: 20.5K lm, DC Power, 120W, Black
FT-GSMJR	Guardian Jr. LED Surface Mount: 5K lm, DC Power, 35W, Chrome
FT-GSMJR-B	Guardian Jr. LED Surface Mount: 5K lm, DC Power, 35W, Black



**HOW TO INSTALL
THE GUARDIAN**



SEMI-RECESSED / RECESSED FIXED AND ADJUSTABLE SCENE LIGHTS



KEY FEATURES

- Requires Less Than 2.5" Mounting Depth
- Multiple Output Options
- Wide Spread Precision Optics

FT-MB-2.15--*-CPREC**
 **-OPTICS (S, F, FT) *-HOUSING COLOR (B, W)

DIMENSIONS

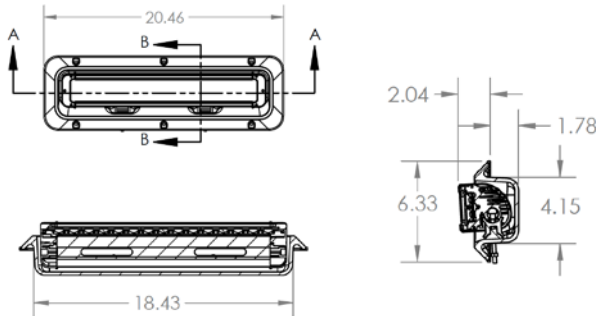

SEMI-RECESSED SCENE LIGHT

LEDS	30 X 5W CREE
RAW LUMENS	15,840
EFFECTIVE LUMENS	11,880
OPT. HOUSING COLORS	BLACK OR CHROME
OPT. BEAM PATTERNS	SPOT, FLOOD, COMBO
DIMENSIONS	20.46" x 6.33" x 3.82"
WATTAGE	150W
AMP DRAW (@12V)	12.5A
INPUT VOLTAGE DC	9-32V DC
EMC APPROVAL	CISPR25 CLASS 1 / CE
VIBRATION RATING	21.2 G _{RMS}

SEMI-RECESSED SCENE LIGHT

The FireTech® FT-MB-2.15-**-*-CPREC is a 150 Watt Semi-Recessed FireTech Double Stack MiniBrow® light. This fixture mounts easily to the side of your apparatus and maintains the fixture's native adjustability. Once it's installed, just aim the light where you need it and lock down the mounting feet. The FT-MB-2.15-CPREC is the perfect addition to the side of any apparatus, new or old.



RECESSED DOUBLE STACK MINIBROW | FT-MB-2.18-REC-**-*



FULLY RECESSED; STICKS OUT LESS THAN 1/4"



FT-MB-2.18-REC--***
**-OPTICS (S, F, FT) *-HOUSING COLOR (B, W)

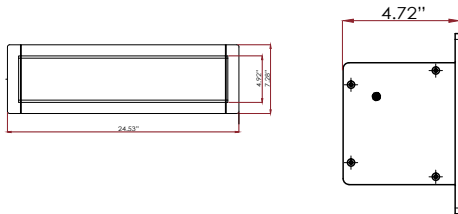

RECESSED DOUBLE STACKED MINIBROW

LEDS	36 X 5W CREE
RAW LUMENS	19,008
EFFECTIVE LUMENS	13,305
OPT. HOUSING COLORS	BLACK OR WHITE
OPT. BEAM PATTERNS	SPOT, FLOOD, COMBO
DIMENSIONS	24.53" x 7.28" x 4.72"
WATTAGE	180W
AMP DRAW (@12V)	15A
INPUT VOLTAGE DC	9-32V DC
CONNECTOR	DEUTSCH DT04-2P
EMC APPROVAL	CISPR25 CLASS 1 / CE
VIBRATION RATING	21.2 G _{RMS}

RECESSED WL-X-9 FIXED & ADJUSTABLE FIXTURES

FIXED MOUNT



GREAT UNDER AERIAL PLATFORMS!

FT-WL-X-9--*-CPREC-FIX**
**-OPTICS (S, F, FT) *-HOUSING COLOR (B, W)

RECESSED WL-X-9 FIXED & ADJUSTABLE

LEDS	9 X 7W CREE
RAW LUMENS	7,200
EFFECTIVE LUMENS	5,734
OPT. HOUSING COLORS	BLACK OR WHITE
OPT. BEAM PATTERNS	SPOT, FLOOD, COMBO
DIMENSIONS	7.74" x 7.73" x 3.22"
WATTAGE	63W
AMP DRAW (@12V)	7A
INPUT VOLTAGE DC	11-65V DC
CONNECTOR	DEUTSCH DT04-2P
EMC APPROVAL	CISPR25 CLASS 1 / CE
VIBRATION RATING	21.2 G _{RMS}

ADJUSTABLE MOUNT



FT-WL-X-9--*-CPREC-ADJ**
**-OPTICS (S, F, FT) *-HOUSING COLOR (B, W)

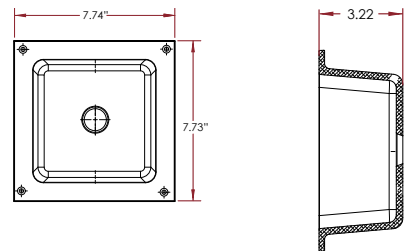

COMPARTMENT & UNDERCARRIAGE LIGHTS





COMPARTMENT & UNDERCARRIAGE LIGHTS





COMPARTMENT & UNDERCARRIAGE

DURABLE AND COMPACT LIGHTS



FT-CU-HD-***

**-LENGTH OF STRIP

*-LED COLOR OPTIONS (RW, RED, BLUE, GREEN)

KEY FEATURES

- Heavy Duty and Ultra Durable
- Ultra Low Profile Design
- LED Color Options Available

DURABLE, SLIM, AND NOW WITH COLORED LEDS

Looking to add more function and style to your new apparatus? We've got you covered! The upgraded HD strip lights are now available with new color LED options that are sure to fit any needs. Choose between a combo red & white LED for more flexibility or a single circuit red, blue, or green output. Completely waterproof, the new HD strip light can confidently be used inside or outside of the apparatus.

MODELS

7.5"	FT-CU-HD7.5-* 9 LEDs 71 EFFECTIVE LM	
12"	FT-CU-HD12-* 21 LEDs 207 EFFECTIVE LM	
24"	FT-CU-HD24-* 48 LEDs 379 EFFECTIVE LM	
36"	FT-CU-HD36-* 75 LEDs 686 EFFECTIVE LM	
48"	FT-CU-HD48-* 96 LEDs 743 EFFECTIVE LM	

SUB-AQUA UNDERCARRIAGE LIGHT | FT-CU-AQX-**-*



SUBMERSIBLE UP TO 100'

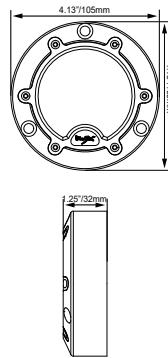

FT-CU-AQX-*
*-HOUSING COLOR (B, W)

SUB-AQUA UNDERCARRIAGE LIGHT

LEDS	6 X 3W
RAW LUMENS	1,500
EFFECTIVE LUMENS	1,050
OPT. HOUSING COLORS	BLACK OR WHITE
OPT. LIGHT COLORS	RED/WHITE OR ALL WHITE
WATTAGE	22W
AMP DRAW (@12V)	1.833A
INPUT VOLTAGE DC	11-32V DC

Available in a Red/White LED Option (use order # FT-CU-AQX-RW-*)
Order P/N FT-CU-AQX-**-KIT for light + mounting bracket

NEW 8" ROUND INTERIOR DOME LIGHT | FT-IDL-8RD-W

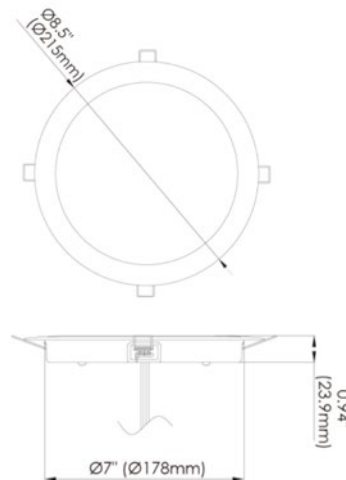

FT-IDL-8RD-W

8" ROUND DOME LIGHT

EFFECTIVE LUMENS	1,625
DIMENSIONS	8.5" x 7" x .94"
WEIGHT	.8 LBS.
BEZEL	WHITE
AMP (@12VDC)	1.02A
WATTS	12.24W
INPUT VOLTAGE DC	12V DC
LED COLOR	WHITE
CERTIFICATIONS	ECE R10; AMD 016

NEW 7X19 DOME LIGHT | FT-IDL-719RCT



FT-IDL-719RCT

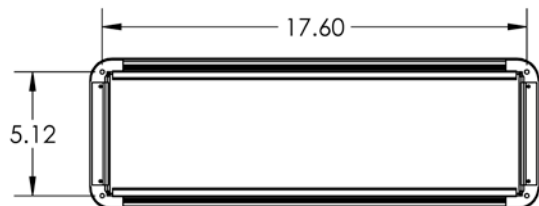

7X19 DOME LIGHT

RAW LUMENS	1,300
EFFECTIVE LUMENS	772
DIMENSIONS	18.62" x 6.3" x .50"
WEIGHT	1 LB.
BEZEL	WHITE
INPUT VOLTAGE DC	10-30V DC
AMP DRAW	1.0A @12V DC
WATTS	12W
LED COLOR	WHITE
CERTIFICATIONS	ECE R10; AMD 016

LIGHT TOWERS

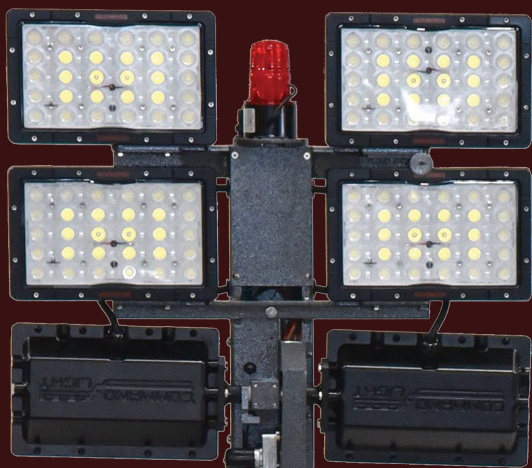



LIGHT TOWERS





LIGHT TOWER FIXTURES DESIGNED TO PUT MORE LUX ON TARGET



WHY CHOOSE FIRETECH LIGHTS IN YOUR LIGHT TOWER

- Symmetrical optics put more light on target
- Higher luminous efficacy means less energy consumed
- Superior warranty covers you for life
- Available in AC or DC

SHAPE OF LIGHT MATTERS

HiViz LED Lighting® designs purpose-built fixtures for light tower applications. Traditional LED scene lights project light down and out, which works great when fix-mounted to the body of a truck. However, when traditional fixtures are tilted down (like on a light tower), the majority of light generated (lumens) ends up on the roof of the apparatus. If the fixtures are tilted backwards, the down-angled optics end up shining up and the beam ends up totally useless to the firefighter. Choosing FireTech® symmetrical optics on light towers will ensure that every lumen created at the source is converted into useful lux on target.



OTHER MANUFACTURERS' ASYMMETRICAL OPTICS

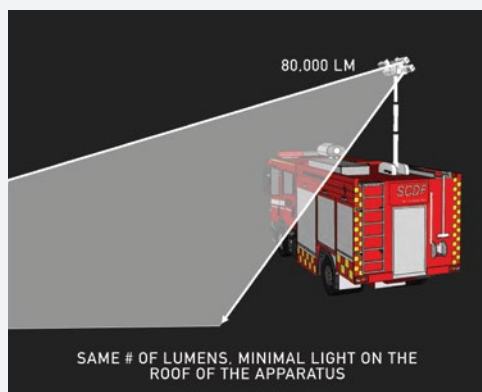

FIRETECH SYMMETRICAL OPTICS



SIRION - 120K LUMENS

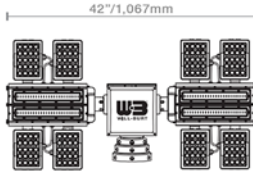

Sirion 2x
Vertical 5.4-17 | 6-20 | 7-25 | 8-30
220,000 Lumens

SIRION
by Will-Burt



Beam Pattern
Triple - Spot / Short & Long Flood



XL-200 - 20K LUMENS

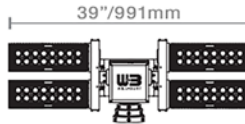

XL-200 4x
Chief | 1.8 | 2.3
80,000 Lumens

XL-200
by Will-Burt



Beam Pattern
Double - Spot / Flood



SCAN FOR FULL
CATALOG

COMMAND LIGHT



CL SERIES

TALLEST TOWER

The CL Series provides the largest reach, nearly 11' from its base.



KL SERIES

MID-SIZE SERIES

Command Light's mid-size Knight Series delivers a reach of nearly 7.5' from its base.



KNIGHT SLIM

NARROW DESIGN

The Slim stows flat at just 12" x 13" x 53" while producing 70,000 total lumens.

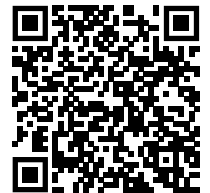

SCAN FOR FULL
CATALOG

POLE LIGHTS





POLE LIGHTS





POLE-MOUNTED LIGHTS

ELEVATION IS THE KEY TO REDUCING GLARE



POLE-MOUNTED GUARDIAN®

KEY FEATURES

- Compact Size
- Less than 20% Thermal Degradation
- 10k and 20k Equivalent Light Output
- AC or DC Operation

DIMENSIONS

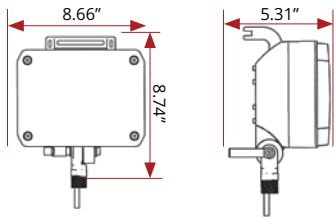

GUARDIAN® STANDARD OUTPUT		GUARDIAN ELITE HIGH OUTPUT	
RAW LUMENS	10,000	RAW LUMENS	20,500
EFFECTIVE LUMENS	6,500	EFFECTIVE LUMENS	12,290
OPT. HOUSING COLORS	BLACK, CHROME	OPT. HOUSING COLORS	BLACK
WATTAGE	75W	WATTAGE	120W
AMP DRAW (@12V)	5.83A	AMP DRAW (@12V)	10.41A
INPUT VOLTAGE DC	9-32V DC	INPUT VOLTAGE DC	9-32V DC

CONFIGURE PART NUMBER

SWITCH OR NO SWITCH ON BACKPLATE

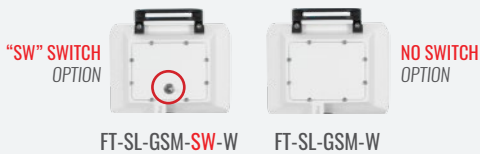

AVAILABLE OUTPUT AND POWER OPTIONS

GSM= STANDARD GUARDIAN
GESM= GUARDIAN ELITE

"110"
DESIGNATES
90-277V AC POWER
(STANDARD IS 9-32V DC)

(OPT) (OPT)
OUTPUT | INPUT | SWITCH | HOUSING

FT-SL-____ - 110-SW-____
GSM B
GESM W

HOUSING COLOR OPTIONS



EXAMPLE CONFIGURATION

FT-SL-GESM-SW-B

GUARDIAN ELITE SCENE LIGHT - BACK SWITCH
9-32V DC INPUT - BLACK HOUSING

20,000 RAW LUMEN LED SCENE LIGHT | FT-SL-15 / FT-SL-X-15



KEY FEATURES

- 1,000-1,500W Halogen Replacement
- Optional 28,000 Lumen "X" Version

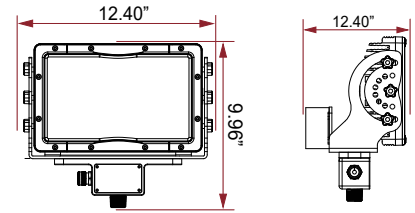

FOR UPGRADED OUTPUT SEE "X" SPECS below

20,000 RAW LUMEN LED SCENE LIGHT

LEDS X	30 X 5W 30 X 7W
RAW LUMENS X	20,000 28,000
EFFECTIVE LUMENS X	11,888 15,305
HOUSING COLOR	BLACK OR WHITE
OPT. BEAM PATTERNS	SPOT, FLOOD, COMBO
DIMENSIONS	11.75" x 7.54" x 4.94"
WATTAGE X	150W 185W
AMP DRAW (@12V)	12.5A 15.4A
INPUT VOLTAGE DC	11-65V DC / 90-277V AC

CONFIGURE PART NUMBER

AVAILABLE OUTPUT AND POWER OPTIONS

"X" DESIGNATES 7W LEDS - HIGH OUTPUT
 "110" DESIGNATES 90-277V AC POWER

SWITCH OR NO SWITCH OPTION

"SW" DESIGNATES SWITCH OPTION

HOUSING COLOR OPTIONS

W=WHITE B=BLACK

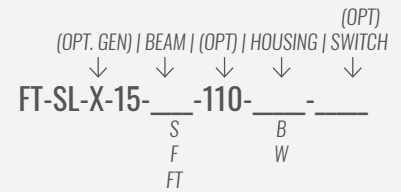

EXAMPLE CONFIGURATION

FT-SL-15-F-110-W-SW

SCENE LIGHT - 30 LED - FLOOD BEAM
 AC POWER MODULE - WHITE HOUSING-SWITCH

30,000 RAW LUMEN LED SCENE LIGHT | FT-SL-30

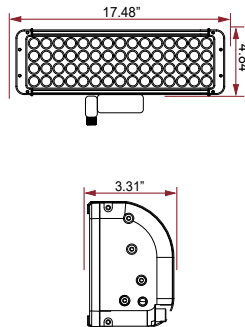

30,000 RAW LUMEN LED SCENE LIGHT

LEDS	60 X 5W
RAW LUMENS	31,680
EFFECTIVE LUMENS	22,200
HOUSING COLOR	BLACK OR WHITE
OPT. BEAM PATTERNS	SPOT, FLOOD, COMBO
DIMENSIONS	17.48" x 4.84" x 3.31"
WATTAGE	300W
AMP DRAW (@12V)	25A
INPUT VOLTAGE DC	11-65V DC

PATRIOT POLE-MOUNTED SCENE LIGHT | FT-PSL

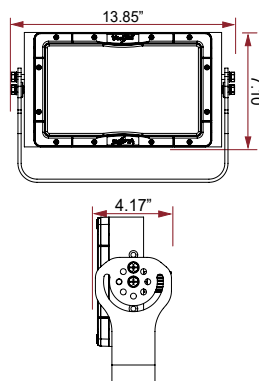

PATRIOT POLE-MOUNTED SCENE LIGHT

LEDS	30
RAW LUMENS DC AC	28,000 31,300
EFFECTIVE LUMENS DC AC	15,305 18,800
HOUSING COLOR	STAINLESS
OPT. BEAM PATTERNS	COMBO
DIMENSIONS	13.85" x 7.10" x 4.17"
WATTAGE DC AC	140W 185W
AMP DRAW (@12V)	15A
INPUT VOLTAGE DC	11-65V DC / 90-277V AC

MADE IN USA

ITEM #	DESCRIPTION
FT-PSL	Patriot Pole-Mounted Scene Light 11-65V DC Input
FT-PSL-110	Patriot Pole-Mounted Scene Light 90-277 AC Input

WORK LIGHTS





WORK LIGHTS





WORK LIGHTS

HIGH LIGHT OUTPUT, COMPACT DESIGN



9 LED WORK & AREA LIGHT KEY FEATURES

- Compact Size
- Patented thermal technology to prevent overheating
- Can withstand vibration up to $21G_{RMS}$
- NFPA 1900 2024 edition compliant at the tip of an aerial

FT-WL-X-9--***
 **-OPTICS (S, F, FT) *-HOUSING COLOR (B, W)

WHY CHOOSE THE WL-X-9?

The FT-WL-X-9 is a 63 watt LED work light designed for use in the fire industry. It meets the minimum NFPA 1900 (2024 revision) illumination requirement for a single 12V LED aerial tip light. This fixture is designed with our patented intelligent Active Thermal Management LED driver which prevents the circuitry from overheating, regardless of the fixture's operating environment. Like the rest of the FireTech® products, the FT-WL-X-9 is backed by our LIFETIME warranty.

DIMENSIONS

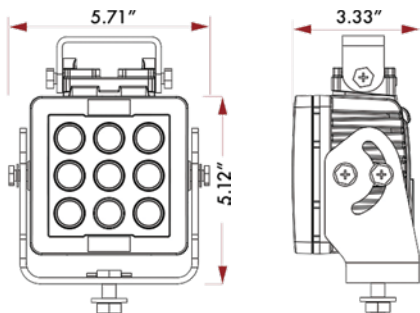

HiViz CONNECT™

NEW Now available with HiViz Connect smart functionality:
P/N: FT-HVC-WL-X-9

9 LED WORK AND AREA LIGHT

LEDS	9 x 7W
RAW LUMENS	7,200
EFFECTIVE LUMENS	5,734
OPT. HOUSING COLORS	BLACK OR WHITE
OPT. BEAM PATTERNS	SPOT, FLOOD, COMBO
DIMENSIONS	5.71" x 5.12" x 3.33"
BUILT-IN SWITCH	YES
WATTAGE	63W
AMP DRAW (@12V)	5.26A
INPUT VOLTAGE DC	11-65V DC
CONNECTOR	DEUTSCH DTO4-2P
EMC APPROVAL	CISPR25 CLASS 3
VIBRATION RATING	21.2 Grms

9 LED ADJUSTABLE WORK & AREA LIGHT | FT-WL-X-9-**-*-SH2



FT-WL-X-9--*-SH2**
**-OPTICS (S, F, FT) *-HOUSING COLOR (B, W)

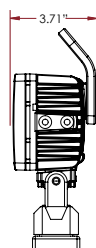
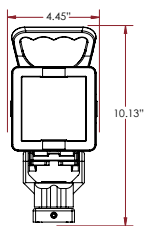

9 LED ADJUSTABLE WORK AND AREA LIGHT

LEDS	9 x 7W
RAW LUMENS	7,200
EFFECTIVE LUMENS	5,734
OPT. HOUSING COLORS	BLACK OR WHITE
OPT. BEAM PATTERNS	SPOT, FLOOD, COMBO
DIMENSIONS	4.45" x 10.13" x 3.71"
BUILT-IN SWITCH	YES
WATTAGE	63W
AMP DRAW (@12V)	5.26A
INPUT VOLTAGE DC	11-65V DC
CONNECTOR	DEUTSCH DT04-2P
EMC APPROVAL	CISPR25 CLASS 3
VIBRATION RATING	21.2 GRMS

20 LED WORK & AREA LIGHT | FT-WL-X-20-**-*



FT-WL-X-20--***
**-OPTICS (S, F, FT) *-HOUSING COLOR (B, W)

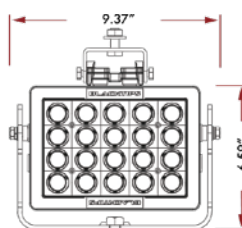

20 LED WORK AND AREA LIGHT

LEDS	20 x 7W
RAW LUMENS	16,000
EFFECTIVE LUMENS	11,270
OPT. HOUSING COLORS	BLACK OR WHITE
OPT. BEAM PATTERNS	SPOT, FLOOD, COMBO
DIMENSIONS	9.37" x 6.59" x 4.13"
BUILT-IN SWITCH	NO
WATTAGE	140W
AMP DRAW (@12V)	11.66A
INPUT VOLTAGE DC	11-65V DC
CONNECTOR	DEUTSCH DT04-2P
EMC APPROVAL	CISPR25 CLASS 3
VIBRATION RATING	21.2 GRMS

12 LED WORK & AREA LIGHT | FT-WL-X-12-**-*



FT-WL-X-12--***
**-OPTICS (S, F, FT) *-HOUSING COLOR (B, W)

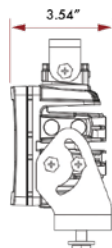
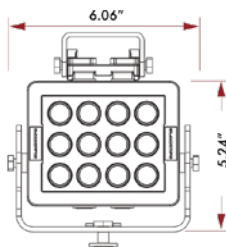

12 LED WORK AND AREA LIGHT

LEDS	12 x 7W
RAW LUMENS	9,600
EFFECTIVE LUMENS	6,697
OPT. HOUSING COLORS	BLACK OR WHITE
OPT. BEAM PATTERNS	SPOT, FLOOD, COMBO
DIMENSIONS	6.06" x 5.24" x 3.54"
BUILT-IN SWITCH	YES
WATTAGE	84W
AMP DRAW (@12V)	7.0A
INPUT VOLTAGE DC	11-65V DC
CONNECTOR	DEUTSCH DT04-2P
EMC APPROVAL	CISPR25 CLASS 3
VIBRATION RATING	21.2 GRMS



5 LED WORK & AREA LIGHT | FT-WL-X-5-**-*

KEY FEATURES

- Outstanding Light Output
- Five Mounting Configurations
- CE Approved
- Anti-Corrosion Coating



FT-WL-X-5--***
**-OPTICS (S, F, FT) *-HOUSING COLOR (B, W)

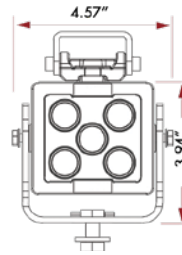

5 LED WORK AND AREA LIGHT

LEDS	5 x 7W
RAW LUMENS	4,000
EFFECTIVE LUMENS	3,305
OPT. HOUSING COLORS	BLACK OR WHITE
OPT. BEAM PATTERNS	SPOT, FLOOD, COMBO
DIMENSIONS	3.94" x 4.57" x 2.95"
BUILT-IN SWITCH	YES
WATTAGE	35W
AMP DRAW (@12V)	2.9A
INPUT VOLTAGE DC	11-65V DC
CONNECTOR	DEUTSCH DT04-2P
EMC APPROVAL	CISPR25 CLASS 3
VIBRATION RATING	21.2 GRMS

4 LED WORK & AREA LIGHT | FT-WL-X-4-*

KEY FEATURES

- 60° Wide Flood Optics
- Flexible Mounting Configurations
- CE Approved
- Anti-Corrosion Coating



FT-WL-X-4-*
*-HOUSING COLOR (B, W)

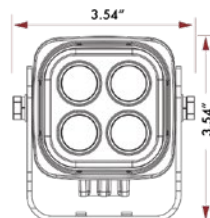

4 LED WORK AND AREA LIGHT

LEDS	4 x 3W
RAW LUMENS	2,000
EFFECTIVE LUMENS	950
OPT. HOUSING COLORS	BLACK OR WHITE
BEAM PATTERN	FLOOD
DIMENSIONS	3.54" x 3.54" x 2.32"
BUILT-IN SWITCH	NO
WATTAGE	12W
AMP DRAW (@12V)	1.0A
INPUT VOLTAGE DC	9-32V DC
CONNECTOR	DEUTSCH DT04-2P
EMC APPROVAL	CISPR25 CLASS 3
VIBRATION RATING	21.2 GRMS

4 LED UTILITY LIGHT | FT-WL-2000-**-*



KEY FEATURES

- Ultra-Reliable Entry Level Utility/ Work Light
- NFPA 1900 2024 compliant rear work light

AVAILABLE WITH **COLORLED** LEDS



FT-WL-2000--***

** -OPTICS (S, F, FT) * -HOUSING COLOR (B, W)

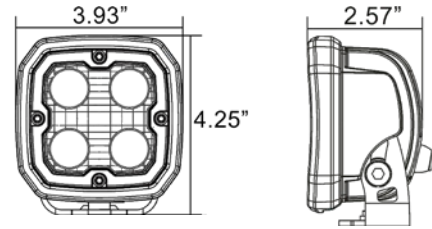

4 LED GENERAL PURPOSE UTILITY LIGHT

LEDS	4 x 5W
RAW LUMENS	2,115
EFFECTIVE LUMENS	1,164
OPT. HOUSING COLORS	BLACK OR WHITE
OPT. ALT. LED COLORS	BLUE, RED, GREEN, AMBER
OPT. BEAM PATTERNS	SPOT, FLOOD, COMBO
DIMENSIONS	3.93" x 4.25" x 2.57"
BUILT-IN SWITCH	NO
WATTAGE	20W
AMP DRAW (@12V)	1.66A
INPUT VOLTAGE DC	9-32V DC
CONNECTOR	DEUTSCH DT04-2P
EMC APPROVAL	CISPR25 CLASS 3

7 LED WORK & AREA LIGHT | FT-WL-3500-**-*

KEY FEATURES

- Ultra-Reliable Work Light
- NFPA 1900 2024 compliant rear work light
- Variety of Optics Available



FT-WL-3500--***

** -OPTICS (S, F, FT) * -HOUSING COLOR (B, W)

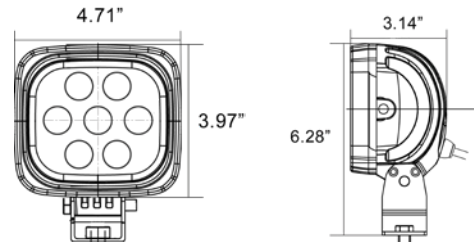

7 LED WORK AND AREA LIGHT

LEDS	7 x 5W
RAW LUMENS	3,696
EFFECTIVE LUMENS	2,587
OPT. HOUSING COLORS	BLACK OR WHITE
OPT. BEAM PATTERNS	SPOT, FLOOD, COMBO
DIMENSIONS	4.71" x 3.97" x 3.14"
BUILT-IN SWITCH	YES
WATTAGE	35W
AMP DRAW (@12V)	2.9A
INPUT VOLTAGE DC	11-65V DC
CONNECTOR	DEUTSCH DT04-2P
EMC APPROVAL	CISPR25 CLASS 3
VIBRATION RATING	15.6 GRMS

SPECIALTY LIGHTS

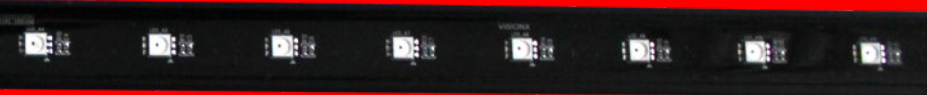



SPECIALTY LIGHTS



PIXEL LADDER LIGHT

THE MOST VERSATILE AERIAL LIGHT EVER CREATED



FT-PXL-61

KEY FEATURES

- Indicate Key Aerial Statuses
- Support up to 5 Ladder Sections
- Choose Any Color/Mode

LIMITLESS FUNCTIONALITY

Adding the Pixel Ladder Light to your fire apparatus aerial device brings a whole new level of sophistication. Each LED in the system is individually controlled by our System Manager, and gives you the ability to choose from a variety of functions on-the-fly. These functions can be solid colors to illuminate the ladder rungs or can be tied to a variety of functions* to indicate certain aerial device statuses. These can include things like flashing when the aerial is in motion, changing colors to indicate when certain load limits are reached, or visually indicating emergency-evacuation or water flowing.

In addition to functionality associated with firefighting, we know aerial devices are often used in parades or community support functions. Supporting the local high school on game night? Fly the school colors! Celebrating Breast Cancer Awareness Month? At the tap of a button, turn the aerial Pink! You can even choose things like "Rocket" or "Twinkle" or "American Flag" all without ever losing the primary function of being the best darn aerial rung light ever produced for a fire apparatus.



CHOOSE ANY COLOR

The system manager allows for user-programmable selection of any "solid" color or combination of colors (white, red, blue, green, orange, pink, rainbow, red/white/blue, etc.).



CHOOSE YOUR FLASH PATTERN

Program any input wire to act as a flashing indicator. This can be wig/wag, scrolling, or blinking and can be used to indicate a variety of aerial conditions.



CHOOSE THE INTENSITY

The entire system is dimmable and can be configured to come on at a variety of intensities.

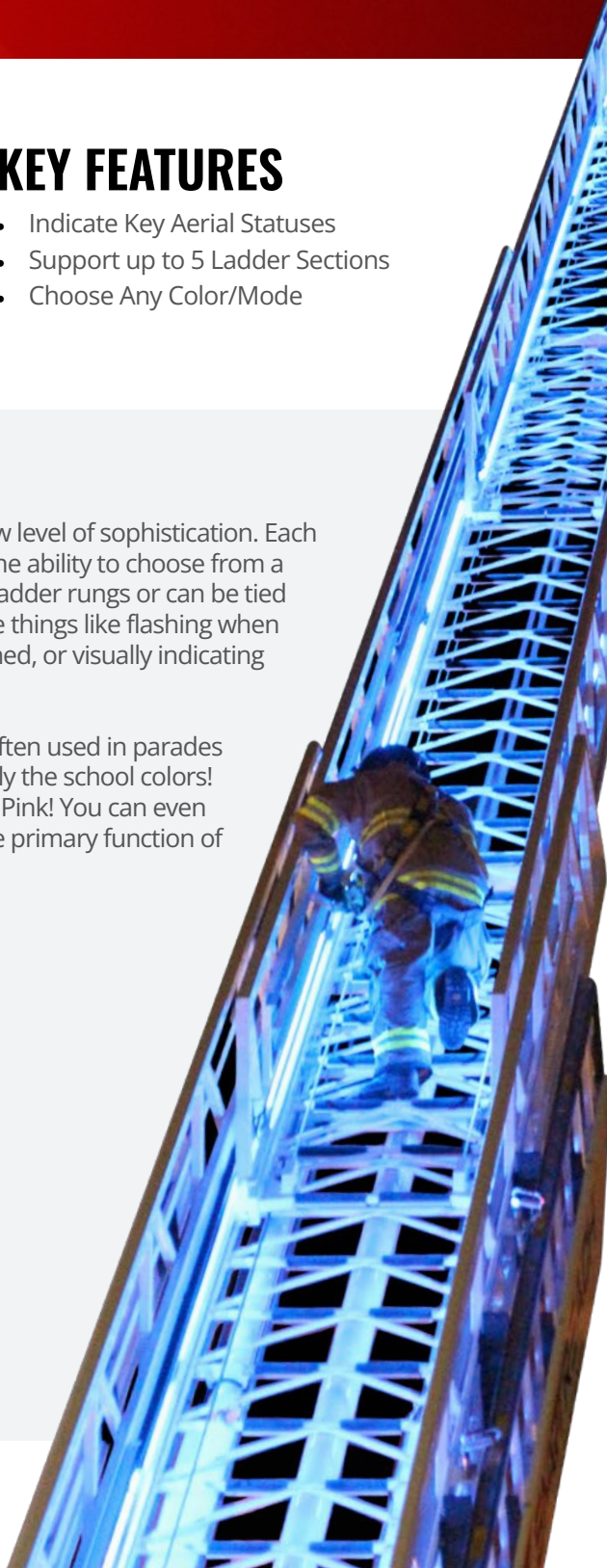



AVAILABLE FUNCTIONS

FULL

Entire light strip on. Color can be any RGB value or white.

WIGWAG

Even/odd groups of the light strip flash on and off at a selected rate.

WIPE

LEDs incrementally turn on going up/down the light strip at a selected rate, creating the effect of lights “wiping” up/down the ladder.

FLASH

Entire light strip flashes on and off at a selected rate.

RAINBOW

Entire light strip turns on and flows rainbow colors up/down the ladder.

TWINKLE

Random LEDs along the light strip twinkle on and off at a selected rate, ramping up in brightness to the “full” state and then back down during the twinkle duration.



PIXEL LADDER LIGHT STRIPS

VOLTAGE RANGE	9-32V DC
AMP DRAW (@12V)	.78A
OPERATING TEMP.	-40C TO 60C
INGRESS PROTECTION RATING	IP67 AND IP6K9K
DIMENSIONS	60.94" x 0.85" x 0.39"

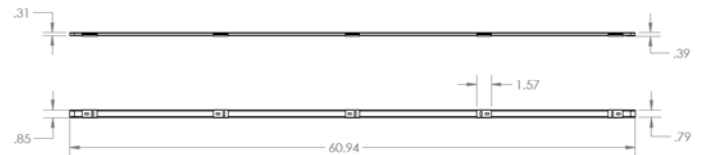

PIXEL CONTROLLER | FT-PXL-SM-001

The Pixel Controller (sold separately), otherwise known as the “System Manager,” has 10 user-programmable input wires. These wires can be assigned to any of the above functions or colors. Apparatus manufacturers can then assign switches or outputs from their electrical system to energize any of the 10 pre-selected functions.

Installation of this product requires engineering support from both the apparatus manufacturer and the FireTech team. Training will be provided to any interested apparatus OEM at no cost. This product may or may not be compatible with certain applications or aerial devices. Custom programming, functionality, and integration support are available to apparatus OEMs.

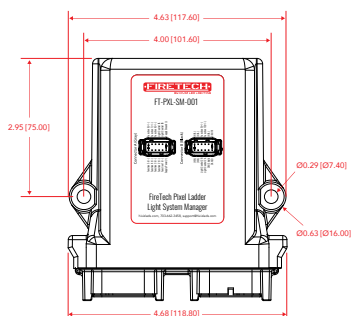

PIXEL CONTROLLER

VOLTAGE RANGE	9-32V DC
OPERATING TEMP.	-40C TO 60C
INGRESS PROTECTION RATING	IP67 AND IP6K9K
RS4-85 BAUD	19,200
DIMENSIONS	4.680" x 5.240" x 1.420"
HARNESS CONNECTORS	DEUTSCH DTM06-12SA + DTM06-12SB



LASER CANNON

PRECISION LASER LIGHTING TECHNOLOGY



KEY FEATURES

- Daytime Visible Class 3b Laser
- High Intensity Spherical-Type Optic
- Compact Design

FT-LZC2-4-B

VISIBLE IN BROAD DAYLIGHT

The major problem the laser cannon addresses is aiding in outrigger placement even during daytime. The high intensity laser emitter and spherical-type optic focuses the laser beam with so much intensity that even during the brightest day the light beam is still visible to the operator.



DIMENSIONS

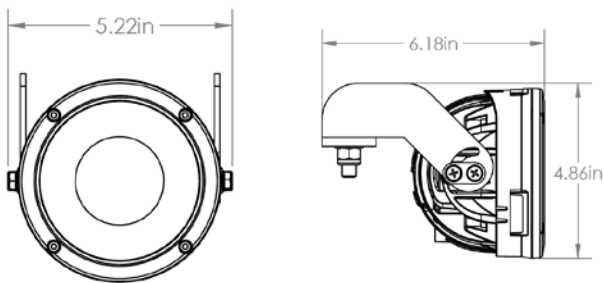

LASER CANNON

LASER	WP-PX BLUE LAKE
EFFECTIVE LUMENS	670
OPT. HOUSING COLORS	BLACK
DIMENSIONS	5.22" x 4.86" x 6.18"
WATTAGE	14W
AMP DRAW (@12V)	1.17A
INPUT VOLTAGE DC	9-32V DC



RETROFIT LIGHTING

REUSE YOUR EXISTING HOUSING



FT-P48-NFKIT

NIGHTFIGHTER KIT

KEY FEATURES

- Direct Drop-In Nightfighter / PAR 46 Replacement
- 2x Flood, 1x Spot Fixture
- Reduced Power Consumption (40W Each)

NIGHTFIGHTER KIT

LEDS	12 x 10W P7 CREE XML LEDS
RAW LUMENS	10,800
EFFECTIVE LUMENS	7,560
HOUSING COLOR	SILVER
OPT. BEAM PATTERNS	SPOT OR FLOOD
REPLACES	ANY PAR46 FIXTURE
WATTAGE	120W

PAR 46 UPGRADE | FT-P48-*



FT-P48-*
*-OPTICS (S, F)

PAR 46 UPGRADE

LEDS	4 x 10W P7 CREE XML LEDS
RAW LUMENS	3,600
EFFECTIVE LUMENS	2,520
HOUSING COLOR	SILVER
OPT. BEAM PATTERNS	SPOT OR FLOOD
REPLACES	ANY PAR46 FIXTURE
WATTAGE	40W

ITEM # DESCRIPTION

FT-P48-F	1x Flood Fixture
FT-P48-S	1x Spot Fixture



FIRETECH® GRILLES

GRILLE REPLACEMENTS



KEY FEATURES

- OEM Location Mounting Uses Factory Installed Mounts
- Meets and Exceeds Necessary Airflow Standards
- Two Single-LED Long Distance Light Cannons
- Two Multi-LED Wide Spot Light Cannons

PURPOSE BUILT FOR YOUR APPARATUS

The FireTech LED Grilles are designed with (4) 7X4 warning lights and (4) off-road light cannons. Two cannons sport a single, highly-focused LED for long distance projection, while the other two multi-optic cannons project light in a wide spot beam to fill in the foreground. These fixtures are a bolt-on solution, giving maximum visibility to the front of your fire or emergency vehicle.



**WATCH THE INSTALLATION VIDEO AND
LEARN MORE ABOUT FIRETECH GRILLES**



FIRETECH GRILLE REPLACEMENT OPTIONS



'11-'16 FORD SUPER DUTY



'17-'19 FORD SUPER DUTY



'20+ FORD SUPER DUTY



'13-'18 DODGE RAM HD



'19+ DODGE RAM HD



'03+ FREIGHTLINER M2



'19+ INTERNATIONAL M7

CONFIGURE PART NUMBER

1.) PICK YOUR MODEL

"03FM2"

'03+ FREIGHTLINER M2

"09F150"

'09-'12 FORD F150

"11FSD"

'11-'16 FORD SUPER DUTY

"17FSD"

'17-'19 FORD SUPER DUTY

"17FSDC"

'17-'19 FORD SUPER DUTY W/CAMERA

"20FSD"

'20+ FORD SUPER DUTY

"20FSDC"

'20+ FORD SUPER DUTY W/CAMERA

"13DHD"

'13-'18 DODGE RAM

(PICK YOUR MODEL CONTINUED)

"19DHD"

'19+ DODGE RAM

"19IM7"

'19+ INTERNATIONAL M7

2.) PICK YOUR WARNING LIGHTS (OPTIONAL)



EACH LIGHT (1-4) IS CONFIGURABLE WITH:

"FR7C-R" - CLEAR LENS, RED LED

"FR7C-B" - CLEAR LENS, BLUE LED

3.) PICK YOUR WARNING LIGHT BEZEL COLOR

"FR7MC"

CHROME TRIM BEZEL

"FR7MB"

BLACK TRIM BEZEL

PICK YOUR MODEL, THEN USE THE CONFIGURATION SHEET TO PICK YOUR (4) WARNING LIGHTS & BEZEL COLOR

MODEL WARNING LIGHTS BEZEL
 ↓ ↓ ↓
 FT-CG2GKIT- _____ - _____ - _____



CAMERA-INTEGRATED LIGHTS

SPECIFIC APPLICATION LIGHTING AND EQUIPMENT



KEY FEATURES

- Easy Install with Existing Display
- Optional Flashing Endcaps
Packaged with 24 LED MiniBrow
- 7" Standalone Display Option (sold separately)
- Optimal Backup Camera

MINIBROW® CAMERA SCENE LIGHT

Visibility is the key to safety on a fire scene. Whether it's lighting a dark area at night or providing a live video feed from one side of the apparatus to the other during the day, the FireTech® brand has you covered. Some of our OEM customers brought us a need for a single fixture with multiple functions, one of them being a need for visibility during the day.

This camera can be wired into a display on a multiplex fire apparatus, or for smaller rigs, can be wired to the factory harness for seamless integration with the truck's factory-installed backup camera system. For rigs without integrated screens or backup systems, a simple aftermarket video monitor can be installed for minimal cost.

MINIBROW CAMERA LIGHT

LEDS	18 x 5W LEDS - 6 x 3W LEDS
RAW LUMENS	9,504 - 19,008
EFFECTIVE LUMENS	6,652 - 13,305
OPT. HOUSING COLORS	BLACK OR WHITE
OPT. BEAM PATTERNS	SPOT, FLOOD, COMBO
LENGTHS	26.39" - 49.09"
INPUT VOLTAGE DC	9-32V DC
CONNECTOR	2X DEUTSCH DT04-2P 1X RCA, 1X 12V CANON

ITEM

- FT-MB-18-C-F-*
- FT-MB-24-C-F-*
- FT-MB-30-C-F-*
- FT-MB-36-C-F-*

DESCRIPTION

- 2x FT-MB-9-F-* + Camera Bridge
- 2x FT-MB-12-F-* + Camera Bridge
- 2x FT-MB-15-F-* + Camera Bridge
- 2x FT-MB-18-F-* + Camera Bridge

LENGTH

- 26.39" Overall
- 33.95" Overall
- 41.51" Overall
- 49.09" Overall

SCAN TO LEARN MORE ABOUT THE MINIBROW CAMERA SCENE LIGHT



LED LIGHT WITH COLOR CAMERA | FT-WL-3500-**-F-*



KEY FEATURES

- Full Color Camera
- Glare Shield Included
- Easy Install with Existing Display
- Powerful LEDs for Night Use



FT-WL-3500--F-***
**-FORWARD OR REAR FACING CAMERA (C, RC)
*-HOUSING COLOR (B, W)

LED LIGHT WITH INTEGRATED COLOR CAMERA

LEDS	6 x 5W
RAW LUMENS	3,168
EFFECTIVE LUMENS	2,217
OPT. HOUSING COLORS	BLACK OR WHITE
BEAM PATTERN	FLOOD
DIMENSIONS	4.72" x 5.50" x 4.88"
WATTAGE	30W
AMP DRAW (@12V)	2.6A
INPUT VOLTAGE DC	9-32V DC
CONNECTOR	DEUTSCH DT04-6P
EMC APPROVAL	CISPR25 CLASS 1 / CE
VIBRATION RATING	15.6 GRMS

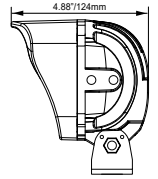
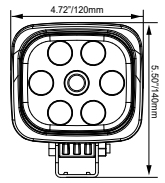

ITEM

DESCRIPTION

FT-WL-3500-C-F-B	Forward Facing Camera, Normal Image, Black Housing
FT-WL-3500-C-F-W	Forward Facing Camera, Normal Image, White Housing
FT-WL-3500-RC-F-B	Forward Facing Camera, Mirror Image, Black Housing
FT-WL-3500-RC-F-W	Forward Facing Camera, Mirror Image, White Housing

FUN FACT ABOUT INVENTORY MANAGEMENT FROM SAM

Once upon a time a monitor that attaches to our cameras lived in this spot. As I was building this product range, we kept hearing from end-user customers that they thought they wanted a monitor to go with the cameras. Naturally, we're a lighting company so designing and manufacturing a monitor system is not our expertise area, so we sourced one. It was really amazing- color monitor, 3 different mounting options, a whole bunch of inputs, and even supported HDMI. We brought in about 100 monitors as a first run, added them to the catalog in 2017, and as of the date of this publication sold a grand total of 3 units. All to a guy in the northeast who put them on his snow plow truck (aka not a fire truck).

The question I never asked was if *fire apparatus manufacturers* would use our monitor, or if they needed us to source one to go with our cameras. We'd been selling cameras like hot cakes, so someone must have had a solution! Had I asked the question, the answer I would have received was that 99% of apparatus purchasers who have backup cameras, get their cameras fed in to the touchscreen on the dash as opposed to an external monitor (think: Vista monitor, CommandZone, or EsKey screen).

In 2023 we scrapped the 95 monitors we didn't sell and deleted the product from our catalog. The moral of the story is that just because you can, doesn't always mean you should. If we'd deployed that capital in to another project or in to creation of a new role, I wonder what the outcome could have been.

We don't have a new product for this space in the catalog, and I thought a bit of a story might be better than some trinket you'd just breeze past anyway.



FOR MORE STORIES LIKE THIS
AND STORIES FROM OTHER FIRST
RESPONDER OWNED BUSINESSES
CHECK OUT **THE 24/48 PODCAST:**

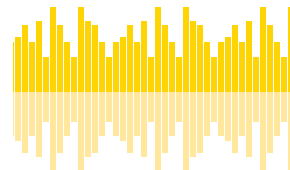

SOFTWARE & ACCESSORIES





SOFTWARE & MOUNTING ACCESSORIES





FIELD SUPPORT TOOL

UPDATING SMART LIGHTS



FT-FIELDSUPPORTTOOL

KEY FEATURES

- Configure “Smart” Products
- Diagnose and transmit trouble areas
- Receives updates from HiViz engineering as features are released

FIELD SUPPORT TOOL

FireTech® “Smart” products like our Pixel Ladder Light, BG2 Smart Lighting System, HiViz Connect™ Warning Lights, and Omen™ Warning Lightbar all receive programming over wire. This tool allows you to configure these products as well as install software updates as they become available. This tool is also extremely helpful in diagnosing problem areas, even connecting back to the HiViz engineering team to “talk to your truck” and see exactly what sort of messages are being sent/received by the lighting system.

This tool is NOT required to use our systems, only to configure it. As such, training is required and this tool is restricted to bonafide dealer, OEM, and up-fitter partners who are in good standing with HiViz. If you are an end-user looking to make updates to your system, contact HiViz and our team will provide more information about shipping a loaner field support tool or scheduling a visit from a qualified HiViz smart product technician.

OMEN WARNING LIGHT ACCESSORIES



HIVIZ CONNECT ZONE CONTROL MODULE



SMART SCENE LIGHT BRIDGE MODULE



HAAS ALERT MOUNTING BRACKET



14 INPUT MODULE



USB PROGRAMMING DONGLE



J-FOOT MOUNT

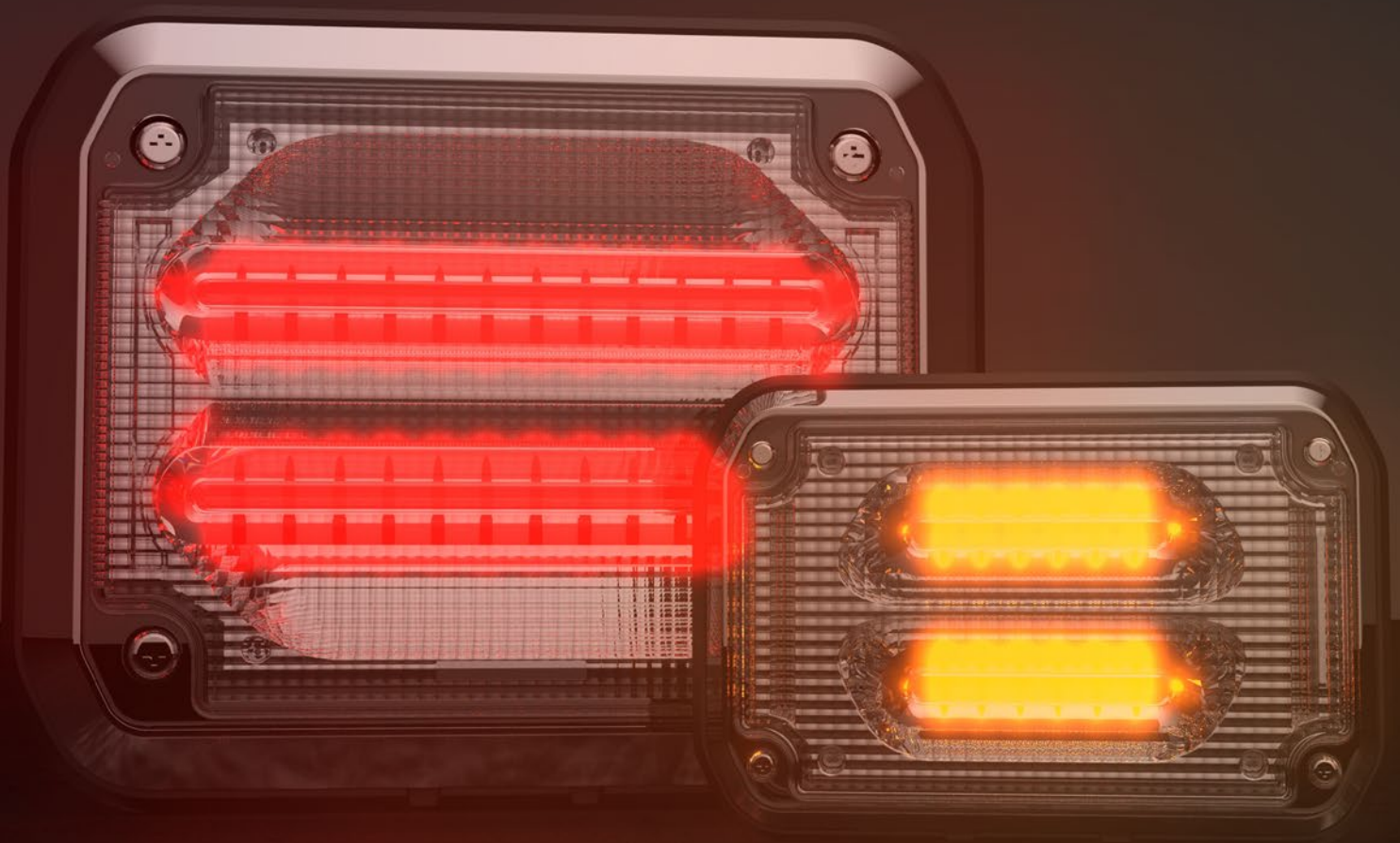

HIVIZ LIGHTING, INC.



149 Twin Springs Road
Hendersonville, NC 28792



P: (703) 662-3458



Firetech@hivizleds.com
Hivizleds.com

FOLLOW US @HIVIZLEDLIGHTING

